

Photoelectric Sensor Selection Manual



Content

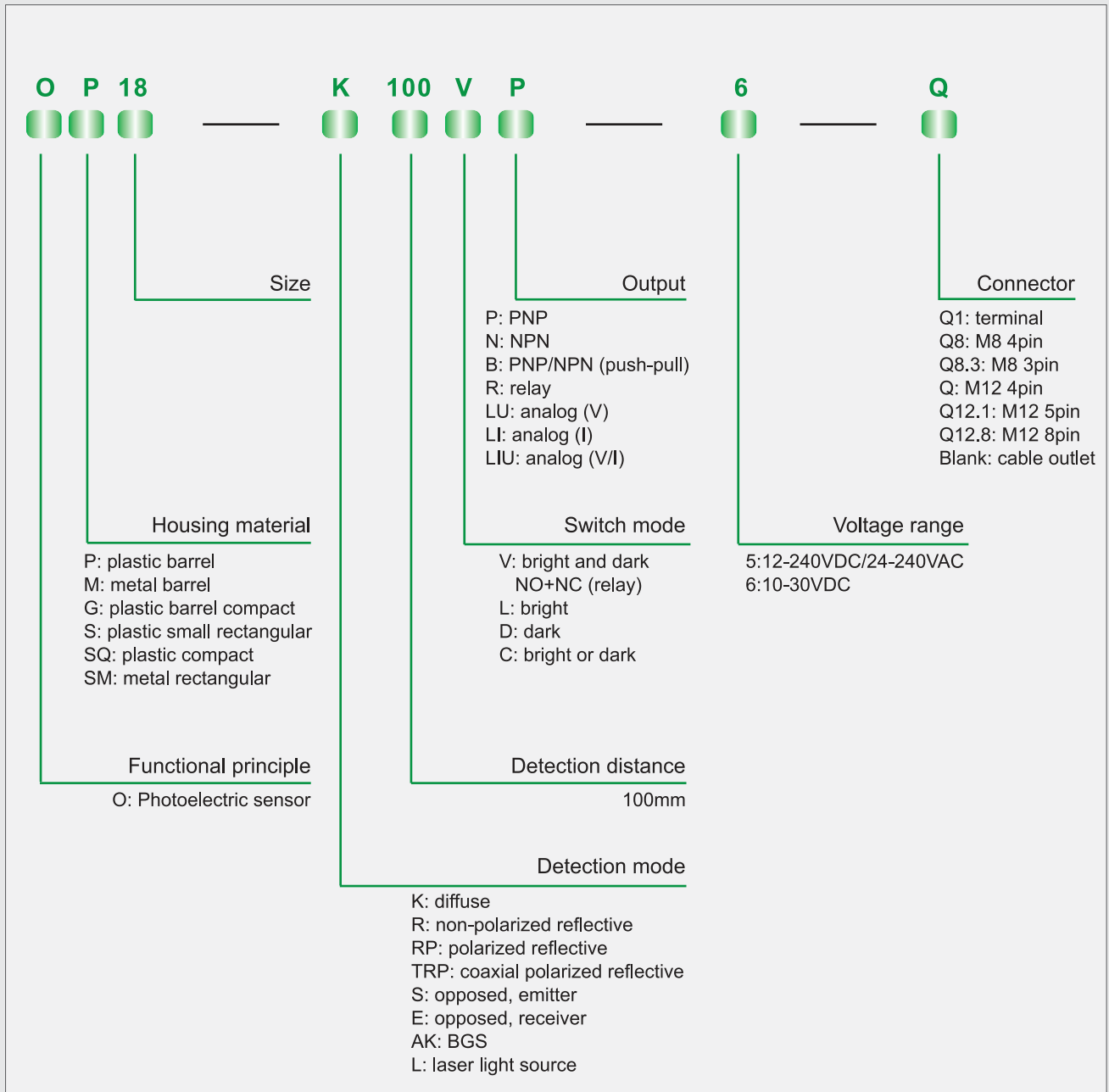

Photoelectric Sensor	Page
Model Description	3
Standard photoelectric sensor	
Barrel sensor	
OP18 series	8
OM18 series	13
Compact sensor	
OG18 series	18
OSQ18 series	22
Rectangular sensor	
OS21 series	26
OS10 series	29
OS20 series	33
OS12 series	35
OS13 series	39
OS50 series	43
OSM70 series	49
Distance measurement sensor	
OSM40 series	52
OSM60 series	55
Accessories	
Connector	58
Reflector	60
Mounting brackets	61
Slit	62

Model Description:



Photoelectric Sensor

	Barrel		Compact
Product picture			
Series	OP18	OM18	OG18
Features	Barrel Cost-effective	Barrel Long distance laser	Barrel Short body
Detection range	Opposed: 10m Retro-reflective: 3m Polarized retro-reflective: 3m Diffused: 0.6m	Opposed: 10m, 60m Retro-reflective: 3m Polarized retro-reflective: 3m Diffused: 0.6m	Opposed: 30m Retro-reflective: 4m Polarized retro-reflective: 4m Diffused: 0.6m
Light source	Red light Infrared light	Laser beam Red light Infrared light	Red light Infrared light
Power supply	10-30VDC	10-30VDC	10-30VDC
Output	NPN/PNP	NPN/PNP	NPN/PNP
Housing material	PC+PBT	Nickel plated brass	ABS+PBT
Protection class	IP67	IP67	IP67

Compact	Rectangular	
		
OSQ18	OS21	OS10
Round hole mounting Screw mounting	Mini size	High precision Laser BGS
Opposed: 30m Retro-reflective: 3.5m Polarized retro-reflective: 3.5m Diffused: 0.6m BGS: 200mm	Opposed: 2m BGS: 15mm 30mm 50mm	Opposed: 30m Polarized retro-reflective: 5m Diffused: 1m BGS: 350mm
Laser beam Red light Infrared light	Red light Infrared light	Laser beam Red light Infrared light
10-30VDC	10-30VDC	10-30VDC
NPN/PNP	NPN/PNP	NPN/PNP
ABS+PBT	PC+ABS	PC+PBT
IP67	IP67	IP67

Photoelectric Sensor

	Rectangular		
Product picture			
Series	OS20	OS12	OS13
Features	High performance Laser BGS	Standard General Economic	Standard General Economic No potentiometer
Detection range	Dynamic and static: 40mm BGS: 1m Transparent: 2.5m Non-coaxial polarized reflective: 5m Coaxial polarized reflective: 5m	Opposed: 10m Retro-reflective: 3m Diffused: 0.4m	Opposed: 10m Retro-reflective: 3m Diffused: 0.2m
Light source	Laser beam Red light	Red light Infrared light	Red light Infrared light
Power supply	10-30VDC	10-30VDC	10-30VDC
Output	NPN/PNP	NPN/PNP	NPN/PNP
Housing material	PC+PBT	PC+PBT	PC+PBT
Protection class	IP67	IP65	IP65

Rectangular

		 Coming 2021	
OS50	OSM40	OSM60	OSM70
Wide voltage Long distance Relay	Metal housing High precision Laser distance measurement	Metal housing Laser distance measurement	Metal housing Long distance Relay
Opposed: 60m Retro-reflective: 10m Polarized retro-reflective: 6m Diffused: 7m	Distance measuring: up to 800mm	Distance measuring: up to 10m	Opposed: 150m Retro-reflective: 30m Polarized retro-reflective: 25m BGS: 3m
Laser beam Red light Infrared light	Laser beam	Laser beam	Laser beam
10-30VDC 24-240V AC/DC	10-30VDC	10-30VDC	10-30VDC 24-240V AC/DC
NPN/PNP, Relay	Push-Pull Analogue	2x Push-Pull Analogue	Push-Pull Relay
PBT+ABS	Stainless steel	Stainless steel	Die-cast zinc
IP67	IP67	IP67	IP67

Photoelectric Sensors—Barrel-OP18



Description:

M18 barrel mounting mode, high cost-effective, OEM variations are optional. Suitable for logistics transportation, textile, garage, electronic industry.

Features:

- General mounting mode
- Bright status indicator

Technical Data:

Operating voltage	10...30VDC
Ripple voltage	≤10%
No-load current	Opposed: ≤25mA; Others: ≤15mA
Output current	≤100mA
Protective circuit	Reverse polarity protection, short circuit protection, Overload protection
Sensitivity	Adjustable, with single-turn knob
Output indicator	Red LED
Steady state indicator	Green LED
Ambient temperature	-25...65°C
Storage temperature	-40...70°C
Voltage withstanding	1000V/AC 50/60Hz 60s
Insulation impedance	≥50MΩ(500VDC)
Shock resistance	Complex amplitude 1.5mm 10... 50Hz (2hr X, Y,Z respectively)
Impact resistance	500m/S ² (50G) 3 times X,Y,Z respectively
Protection class	IP67
Housing material	PC+PBT

Type:

Detection mode	Type	Distance	Light source	Frequency	Output	Switching mode	Connection	Wiring
Opposed	OP18-S6 (emitter)	10m	Infrared	— —	— —	— —	2m cable	Fig.1
	OP18-EVP6 (receiver)		— —	100Hz	PNP	NO+NC	2m cable	Fig.3
	OP18-EVN6 (receiver)		— —	100Hz	NPN	NO+NC	2m cable	Fig.4
	OP18-S6Q (emitter)	10m	Infrared	— —	— —	— —	M12 connector	Fig.2
	OP18-EVP6Q (receiver)		— —	100Hz	PNP	NO+NC	M12 connector	Fig.5
	OP18-EVN6Q (receiver)		— —	100Hz	NPN	NO+NC	M12 connector	Fig.6

The detection distance corresponds to the reflector RB50*50-1 (purchased separately)

Retro-reflective	OP18-RVP6	3m	Infrared	100Hz	PNP	NO+NC	2m cable	Fig.3
	OP18-RVN6	3m	Infrared	100Hz	NPN	NO+NC	2m cable	Fig.4
	OP18-RVP6Q	3m	Infrared	100Hz	PNP	NO+NC	M12 connector	Fig.5
	OP18-RVN6Q	3m	Infrared	100Hz	NPN	NO+NC	M12 connector	Fig.6
Polarized retro-reflective	OP18-RPVP6	3m	Red	100Hz	PNP	NO+NC	2m cable	Fig.3
	OP18-RPVN6	3m	Red	100Hz	NPN	NO+NC	2m cable	Fig.4
	OP18-RPVP6Q	3m	Red	100Hz	PNP	NO+NC	M12 connector	Fig.5
	OP18-RPVN6Q	3m	Red	100Hz	NPN	NO+NC	M12 connector	Fig.6

Diffused	OP18-K100VP6	100mm	Infrared	100Hz	PNP	NO+NC	2m cable	Fig.3
	OP18-K100VN6	100mm	Infrared	100Hz	NPN	NO+NC	2m cable	Fig.4
	OP18-K100VP6Q	100mm	Infrared	100Hz	PNP	NO+NC	M12 connector	Fig.5
	OP18-K100VN6Q	100mm	Infrared	100Hz	NPN	NO+NC	M12 connector	Fig.6
	OP18-K200VP6	200mm	Infrared	100Hz	PNP	NO+NC	2m cable	Fig.3
	OP18-K200VN6	200mm	Infrared	100Hz	NPN	NO+NC	2m cable	Fig.4
	OP18-K200VP6Q	200mm	Infrared	100Hz	PNP	NO+NC	M12 connector	Fig.5
	OP18-K200VN6Q	200mm	Infrared	100Hz	NPN	NO+NC	M12 connector	Fig.6
	OP18-K400VP6	400mm	Infrared	100Hz	PNP	NO+NC	2m cable	Fig.3
	OP18-K400VN6	400mm	Infrared	100Hz	NPN	NO+NC	2m cable	Fig.4
	OP18-K400VP6Q	400mm	Infrared	100Hz	PNP	NO+NC	M12 connector	Fig.5
	OP18-K400VN6Q	400mm	Infrared	100Hz	NPN	NO+NC	M12 connector	Fig.6
	OP18-K600VP6	600mm	Infrared	100Hz	PNP	NO+NC	2m cable	Fig.3
	OP18-K600VN6	600mm	Infrared	100Hz	NPN	NO+NC	2m cable	Fig.4
	OP18-K600VP6Q	600mm	Infrared	100Hz	PNP	NO+NC	M12 connector	Fig.5
	OP18-K600VN6Q	600mm	Infrared	100Hz	NPN	NO+NC	M12 connector	Fig.6

Photoelectric Sensors—Barrel-OP18

Wiring:

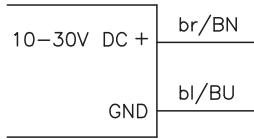

Fig.1

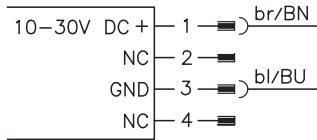

Fig.2

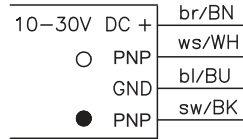

Fig.3

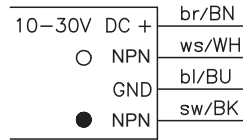

Fig.4

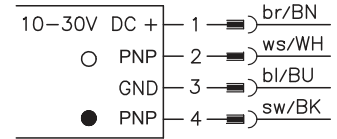

Fig.5

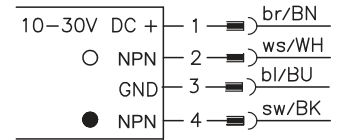
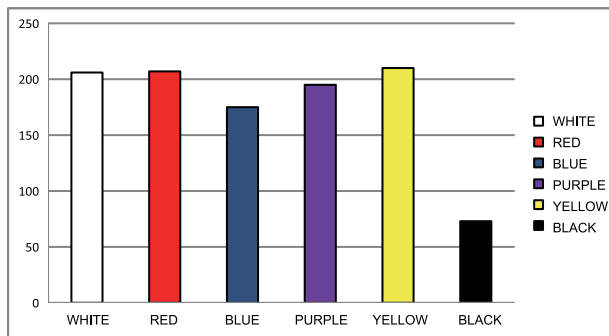

Fig.6

Functional characteristics:

OP18-K100VP6 diffused attenuation figure



OP18-K200VP6 diffused attenuation figure

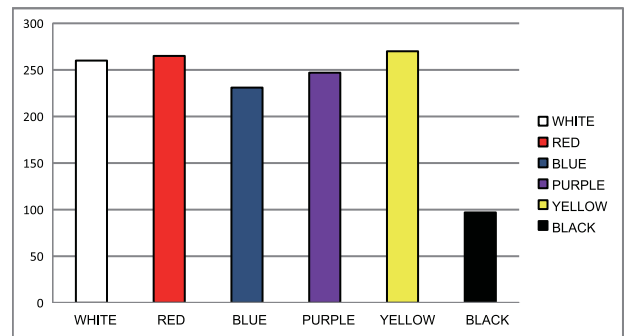

OP18-K400VP6 diffused attenuation figure

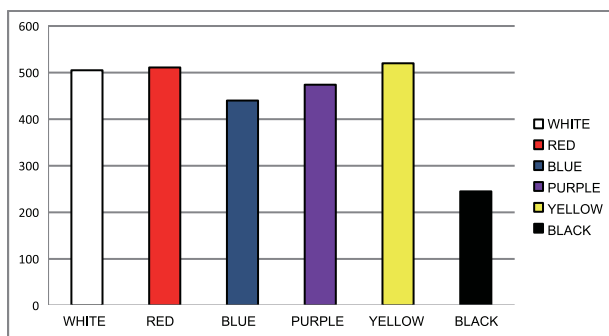

OP18-K600VP6 diffused attenuation figure

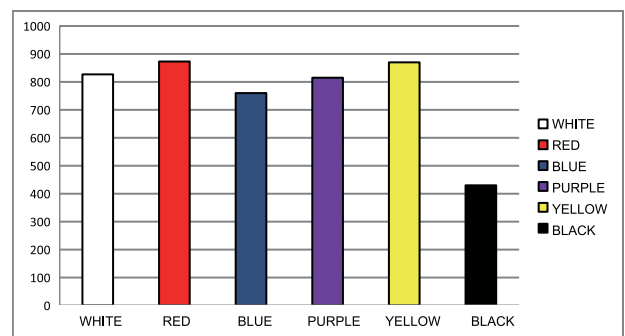

Functional characteristics:

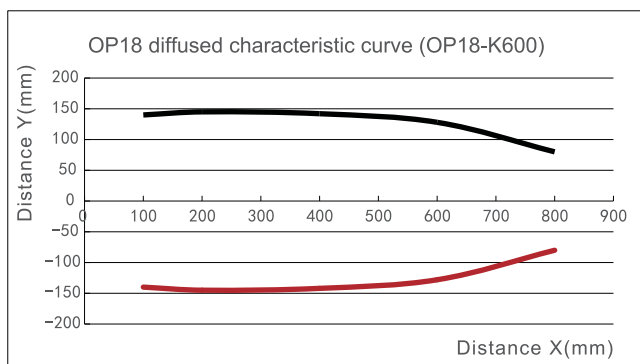
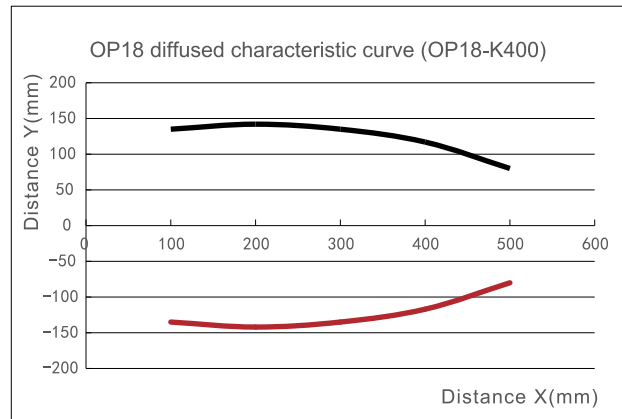
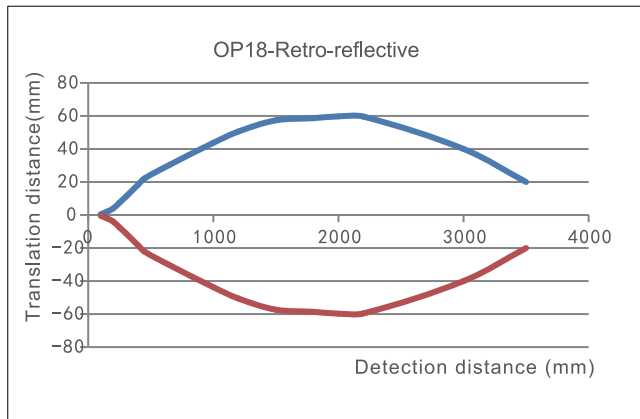
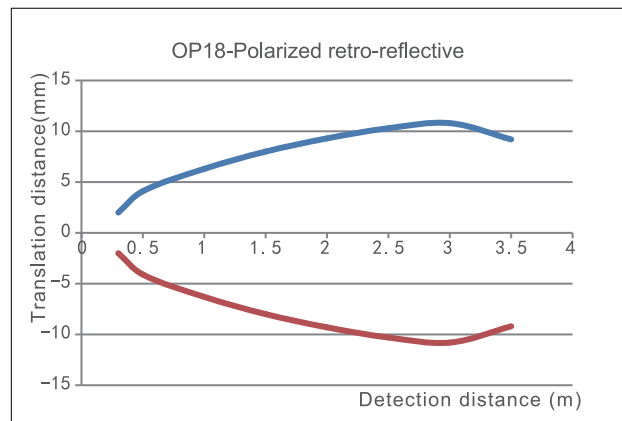
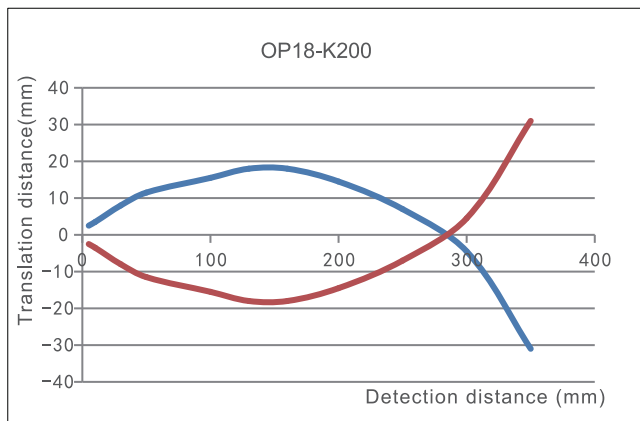
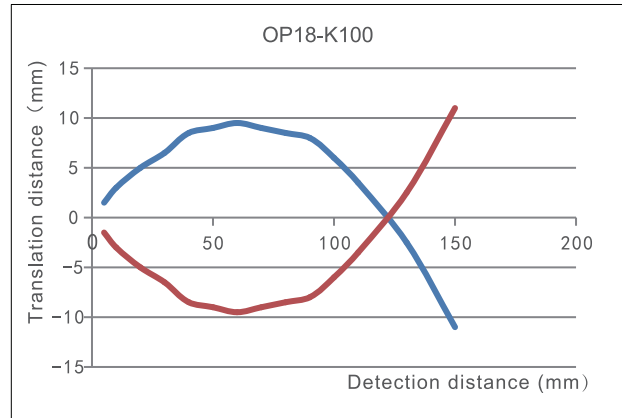
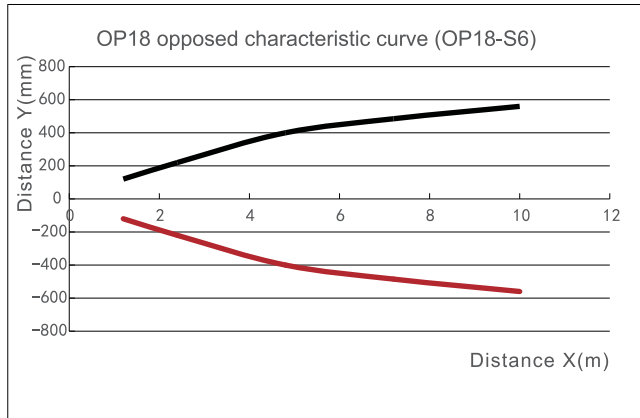

Dimensions:

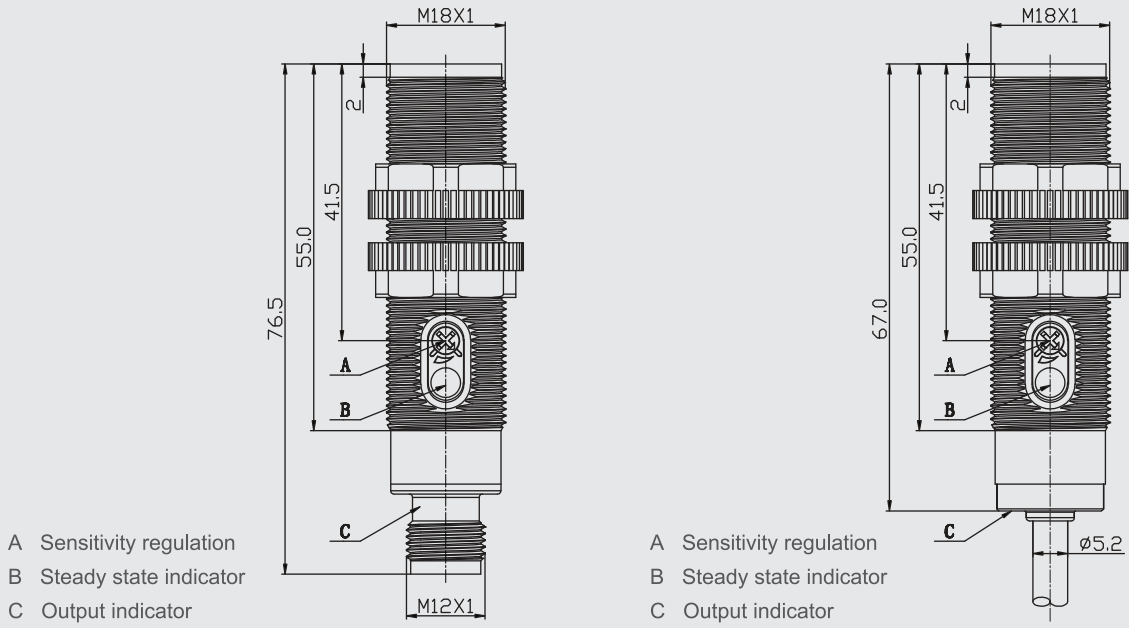

Reflector (optional):

RB50x50-1

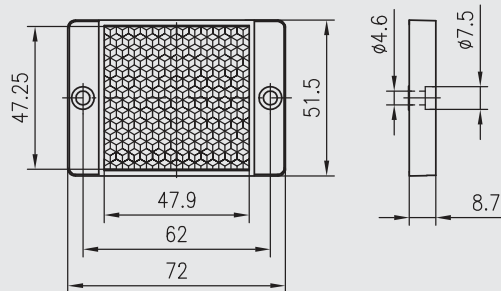



Description:

M18 barrel mounting mode, metal housing.
 Suitable for logistics transportation, food&beverage, printing, small equipment and others.

Features:

- Strong impact resistance
- 60m laser opposed

Technical Data:

Operating voltage	10...30VDC
Ripple voltage	≤10%
No-load current	Opposed: ≤25mA; Others: ≤15mA
Output current	≤100mA
Protective circuit	Reverse polarity protection, short circuit protection, Overload protection
Sensitivity	Adjustable, with single-turn knob
Output indicator	Red LED
Steady state indicator	Green LED
Ambient temperature	-25...65°C
Storage temperature	-40...70°C
Voltage resistance	1000V/AC 50/60Hz 60s
Insulation impedance	≥50MΩ(500VDC)
Shock resistance	Complex amplitude 1.5mm 10... 50Hz (2hr X, Y ,Z respectively)
Impact resistance	500m/S ² (50G) 3 times X,Y,Z respectively
Protection class	IP67
Housing material	Brass nickel-plated

Type:

Detection mode	Type	Distance	Light source	Frequency	Output	Switching mode	Connection	Wiring
Opposed	OM18-S6(emitter)	10m	Infrared	— —	— —	— —	2m cable	Fig.1
	OM18-EVP6 (receiver)		— —	100Hz	PNP	NO+NC	2m cable	Fig.3
	OM18-EVN6 (receiver)		— —	100Hz	NPN	NO+NC	2m cable	Fig.4
	OM18-S6Q (emitter)	10m	Infrared	— —	— —	— —	M12 connector	Fig.2
	OM18-EVP6Q (receiver)		— —	100Hz	PNP	NO+NC	M12 connector	Fig.5
	OM18-EVN6Q (receiver)		— —	100Hz	NPN	NO+NC	M12 connector	Fig.6
	OM18-SL306	30m	laser	— —	— —	— —	2m cable	Fig.1
	OM18-EL30VP6		laser	800Hz	PNP	NO+NC	2m cable	Fig.3
	OM18-EL30VN6		laser	800Hz	NPN	NO+NC	2m cable	Fig.4
	OM18-SL306Q	30m	laser	— —	— —	— —	M12 connector	Fig.2
	OM18-EL30VP6Q		laser	800Hz	PNP	NO+NC	M12 connector	Fig.5
	OM18-EL30VN6Q		laser	800Hz	NPN	NO+NC	M12 connector	Fig.6
	OM18-SL606	60m	laser	— —	— —	— —	2m cable	Fig.1
	OM18-EL60VP6		laser	800Hz	PNP	NO+NC	2m cable	Fig.3
	OM18-EL60VN6		laser	800Hz	NPN	NO+NC	2m cable	Fig.4
	OM18-SL606Q	60m	laser	— —	— —	— —	M12 connector	Fig.2
	OM18-EL60VP6Q		laser	800Hz	PNP	NO+NC	M12 connector	Fig.5
	OM18-EL60VN6Q		laser	800Hz	NPN	NO+NC	M12 connector	Fig.6

The detection distance corresponds to the reflector RB50*50-1 (purchased separately)

Retro-reflective	OM18-RVP6	3m	Infrared	100Hz	PNP	NO+NC	2m cable	Fig.3
	OM18-RVN6	3m	Infrared	100Hz	NPN	NO+NC	2m cable	Fig.4
	OM18-RVP6Q	3m	Infrared	100Hz	PNP	NO+NC	M12 connector	Fig.5
	OM18-RVN6Q	3m	Infrared	100Hz	NPN	NO+NC	M12 connector	Fig.6
Polarized retro-reflective	OM18-RPVP6	3m	Red	100Hz	PNP	NO+NC	2m cable	Fig.3
	OM18-RPVN6	3m	Red	100Hz	NPN	NO+NC	2m cable	Fig.4
	OM18-RPVP6Q	3m	Red	100Hz	PNP	NO+NC	M12 connector	Fig.5
	OM18-RPVN6Q	3m	Red	100Hz	NPN	NO+NC	M12 connector	Fig.6

Diffused	OM18-K100VP6	100mm	Infrared	100Hz	PNP	NO+NC	2m cable	Fig.3
	OM18-K100VN6	100mm	Infrared	100Hz	NPN	NO+NC	2m cable	Fig.4
	OM18-K100VP6Q	100mm	Infrared	100Hz	PNP	NO+NC	M12 connector	Fig.5
	OM18-K100VN6Q	100mm	Infrared	100Hz	NPN	NO+NC	M12 connector	Fig.6
	OM18-K200VP6	200mm	Infrared	100Hz	PNP	NO+NC	2m cable	Fig.3
	OM18-K200VN6	200mm	Infrared	100Hz	NPN	NO+NC	2m cable	Fig.4
	OM18-K200VP6Q	200mm	Infrared	100Hz	PNP	NO+NC	M12 connector	Fig.5
	OM18-K200VN6Q	200mm	Infrared	100Hz	NPN	NO+NC	M12 connector	Fig.6
	OM18-K400VP6	400mm	Infrared	100Hz	PNP	NO+NC	2m cable	Fig.3
	OM18-K400VN6	400mm	Infrared	100Hz	NPN	NO+NC	2m cable	Fig.4
	OM18-K400VP6Q	400mm	Infrared	100Hz	PNP	NO+NC	M12 connector	Fig.5
	OM18-K400VN6Q	400mm	Infrared	100Hz	NPN	NO+NC	M12 connector	Fig.6
	OM18-K600VP6	600mm	Infrared	100Hz	PNP	NO+NC	2m cable	Fig.3
	OM18-K600VN6	600mm	Infrared	100Hz	NPN	NO+NC	2m cable	Fig.4
	OM18-K600VP6Q	600mm	Infrared	100Hz	PNP	NO+NC	M12 connector	Fig.5
	OM18-K600VN6Q	600mm	Infrared	100Hz	NPN	NO+NC	M12 connector	Fig.6

Wiring:

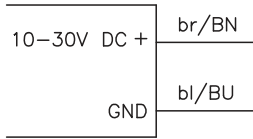

Fig.1

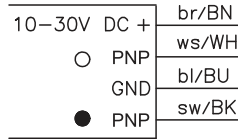

Fig.3

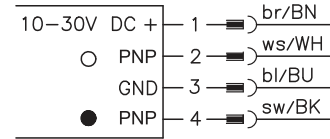

Fig.5

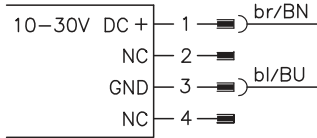

Fig.2

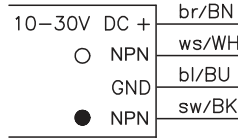

Fig.4

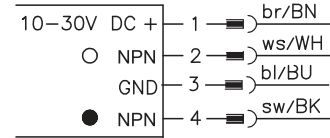
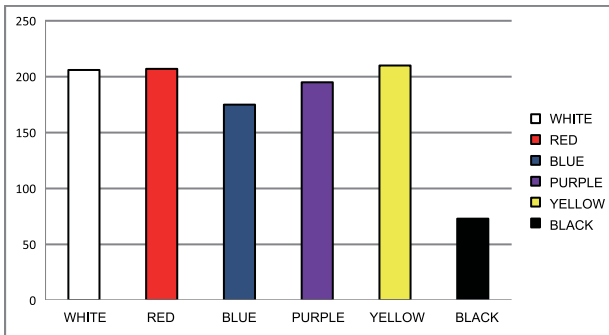

Fig.6

Functional characteristics:

OM18-K100VP6 diffused attenuation figure



OM18-K200VP6 diffused attenuation figure

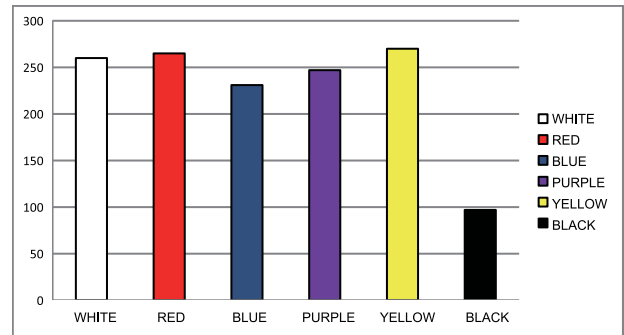

OM18-K400VP6 diffused attenuation figure

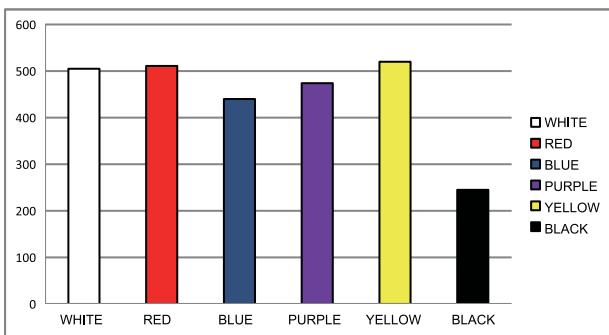

OM18-K600VP6 diffused attenuation figure

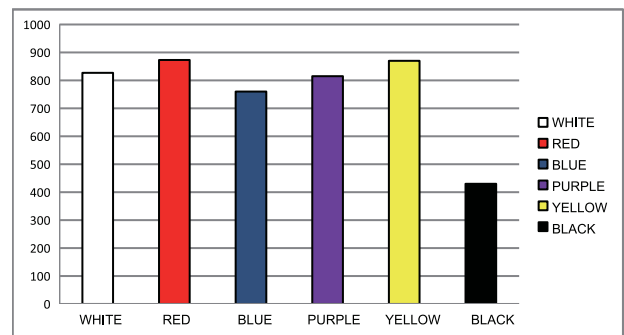

Photoelectric Sensors—Barrel-OM18

Functional characteristics:

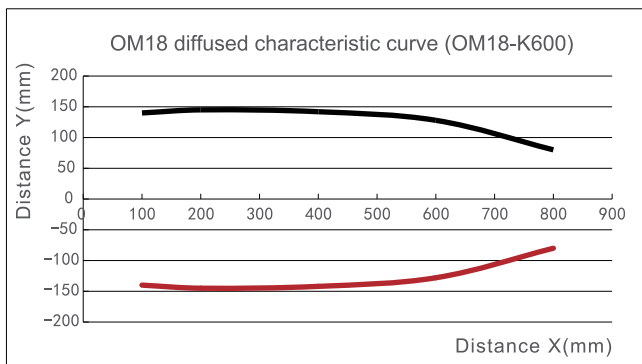
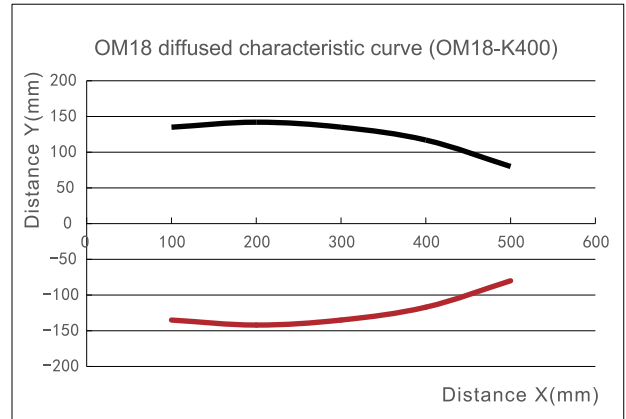
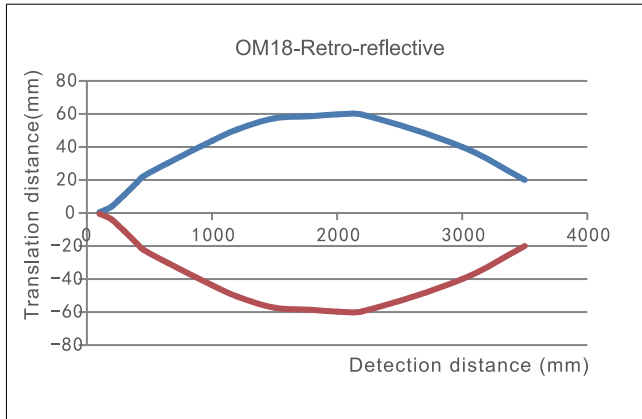
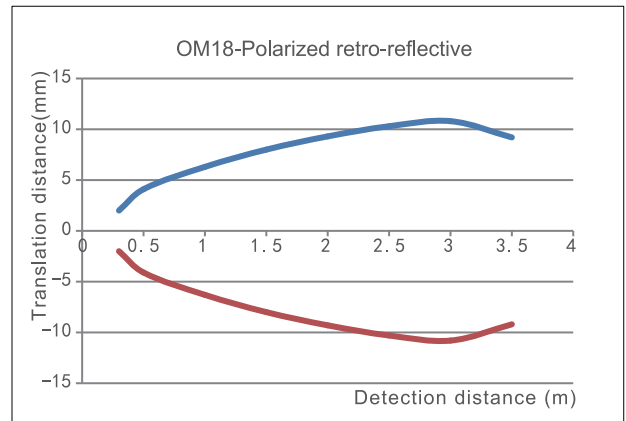
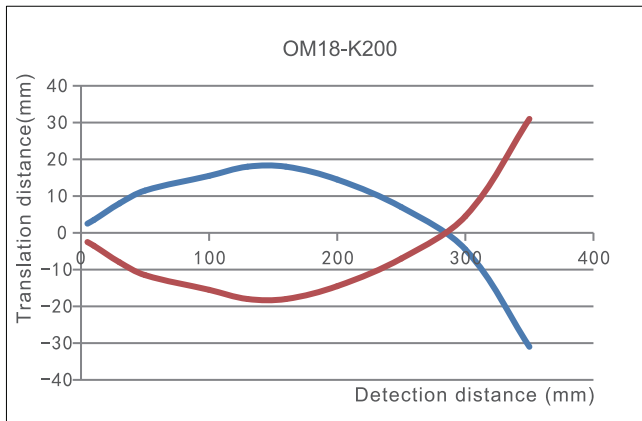
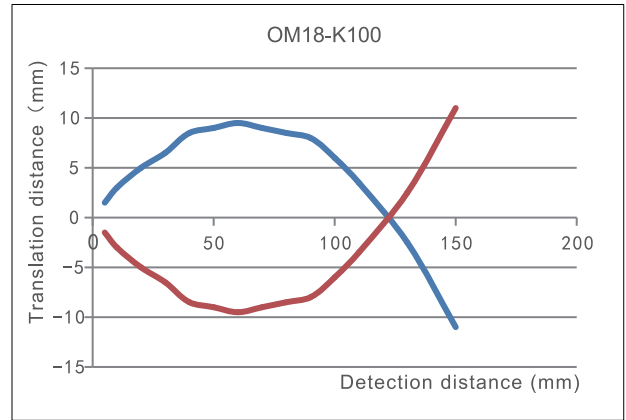
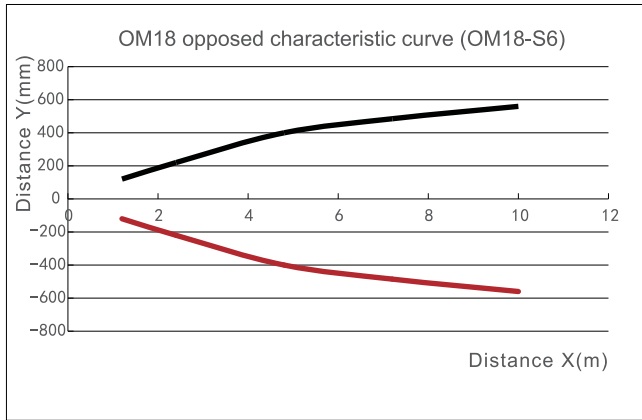

Dimensions:

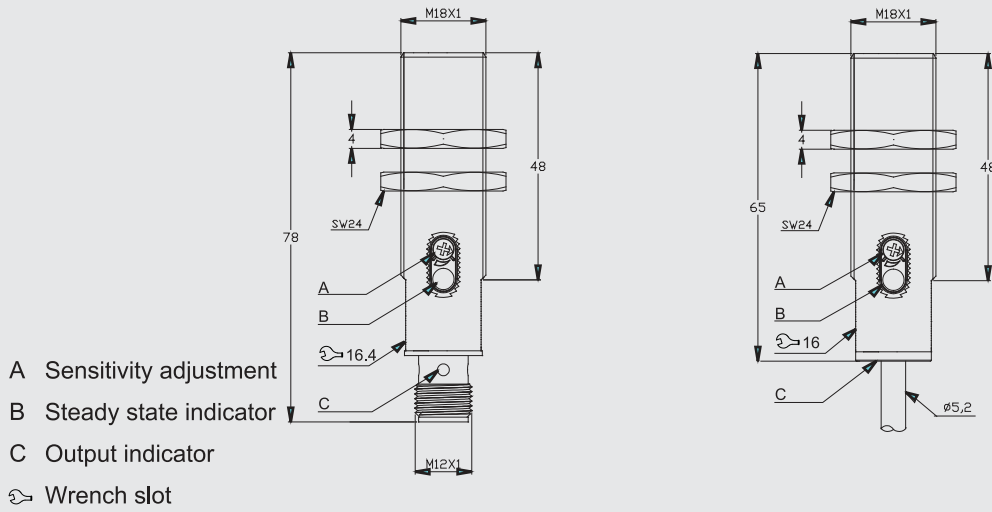

Mounting bracket (optional):

EO18DF

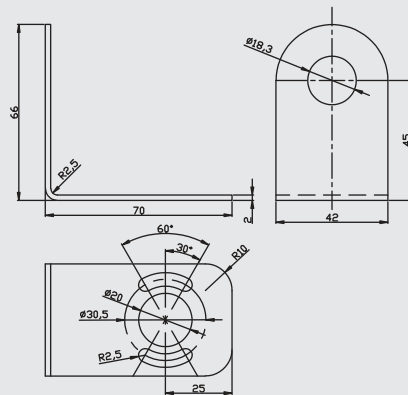

Reflector (optional):

RB50x50-1

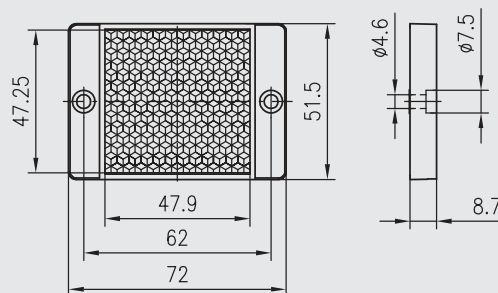

Photoelectric Sensors—Compact-OG18



Description:

M18 barrel mounting mode, length 40mm, according to the needs of use, can provide red, infrared opposed products. Suitable for logistics transportation, gates, packaging and AGV.

Features:

- Compact size
- Long sensing range
- Visible red LED light source

Sensor function description:

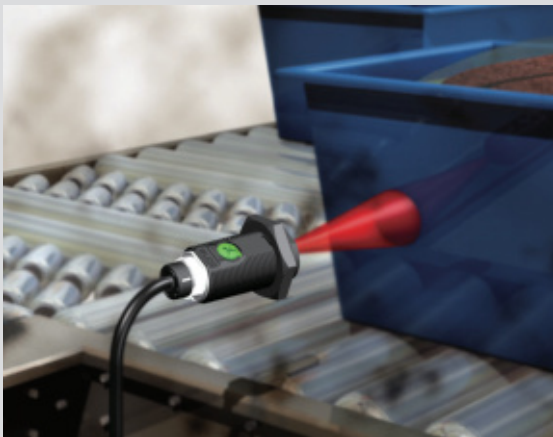

The embedded mounting bracket accessory enables the sensor to be flush mounted on the surface of the equipment, saving mounting time and reducing occupancy space

Clear and bright red LED visible light source, clear illumination position and long-distance position detection, suitable for various equipment applications

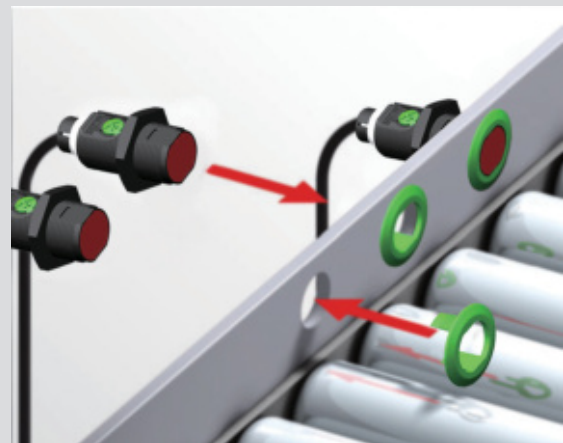

Type:

Detection mode	Type	Distance	Light source	Frequency	Output	Switching mode	Connection	Wiring
Opposed	OG18-S6 (emitter)	30m	Infrared	— —	— —	— —	2m cable	Fig.1
	OG18-ECP6 (receiver)		— —	800Hz	PNP	Light-on / Dark-on	2m cable	Fig.3
	OG18-ECN6 (receiver)		— —	800Hz	NPN	Light-on / Dark-on	2m cable	Fig.2
	OG18-S6Q (emitter)	30m	Infrared	— —	— —	— —	M12 connector	Fig.4
	OG18-ECP6Q (receiver)		— —	800Hz	PNP	Light-on / Dark-on	M12 connector	Fig.5
	OG18-ECN6Q (receiver)		— —	800Hz	NPN	Light-on / Dark-on	M12 connector	Fig.6

Retro-reflective	OG18-RCP6	4m	Red	800Hz	PNP	Light-on / Dark-on	2m cable	Fig.3
	OG18-RCN6	4m	Red	800Hz	NPN	Light-on / Dark-on	2m cable	Fig.2
	OG18-RCP6Q	4m	Red	800Hz	PNP	Light-on / Dark-on	M12 connector	Fig.6
	OG18-RCN6Q	4m	Red	800Hz	NPN	Light-on / Dark-on	M12 connector	Fig.5
Polarized retro-reflective	OG18-RPCP6	4m	Red	800Hz	PNP	Light-on / Dark-on	2m cable	Fig.3
	OG18-RPCN6	4m	Red	800Hz	NPN	Light-on / Dark-on	2m cable	Fig.2
	OG18-RPCP6Q	4m	Red	800Hz	PNP	Light-on / Dark-on	M12 connector	Fig.6
	OG18-RPCN6Q	4m	Red	800Hz	NPN	Light-on / Dark-on	M12 connector	Fig.5

Diffused	OG18-K200CP6	200mm	Red	800Hz	PNP	Light-on / Dark-on	2m cable	Fig.3
	OG18-K200CN6	200mm	Red	800Hz	NPN	Light-on / Dark-on	2m cable	Fig.2
	OG18-K200CP6Q	200mm	Red	800Hz	PNP	Light-on / Dark-on	M12 connector	Fig.6
	OG18-K200CN6Q	200mm	Red	800Hz	NPN	Light-on / Dark-on	M12 connector	Fig.5
	OG18-K400CP6	400mm	Red	800Hz	PNP	Light-on / Dark-on	2m cable	Fig.3
	OG18-K400CN6	400mm	Red	800Hz	NPN	Light-on / Dark-on	2m cable	Fig.2
	OG18-K400CP6Q	400mm	Red	800Hz	PNP	Light-on / Dark-on	M12 connector	Fig.6
	OG18-K400CN6Q	400mm	Red	800Hz	NPN	Light-on / Dark-on	M12 connector	Fig.5
	OG18-K600CP6	600mm	Red	800Hz	PNP	Light-on / Dark-on	2m cable	Fig.3
	OG18-K600CN6	600mm	Red	800Hz	NPN	Light-on / Dark-on	2m cable	Fig.2
	OG18-K600CP6Q	600mm	Red	800Hz	PNP	Light-on / Dark-on	M12 connector	Fig.6
	OG18-K600CN6Q	600mm	Red	800Hz	NPN	Light-on / Dark-on	M12 connector	Fig.5

Photoelectric Sensors—Compact-OG18

Technical Data:

Operating voltage	10...30VDC
Ripple voltage	≤10%
No-load current	Opposed: ≤25mA; Others: ≤15mA
Load current	≤200mA
Protective circuit	Reverse polarity protection, short circuit protection, Overload protection
Sensitivity	Adjustable, with single-turn knob
Output indicator	Red LED
Steady state indicator	Green LED
Ambient temperature	-25...55°C
Storage temperature	-40...70°C
Voltage resistance	1000V/AC 50/60Hz 60s
Insulation impedance	≥50MΩ(500VDC)
Shock resistance	Complex amplitude 1.5mm 10... 50Hz (2hr X, Y,Z respectively)
Impact resistance	500m/S ² (50G) 3 times X,Y,Z respectively
Protection class	IP67
Housing material	PBT+ABS

Wiring:

Pre-wired cable

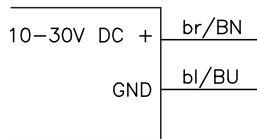

Fig.1

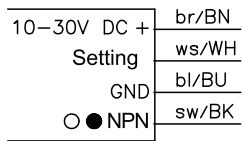

Fig.2

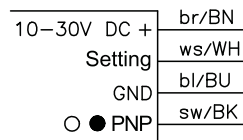

Fig.3

M12 connector

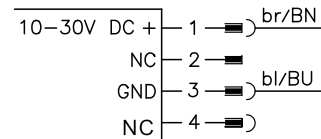

Fig.4

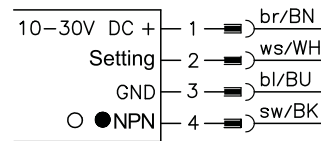

Fig.5

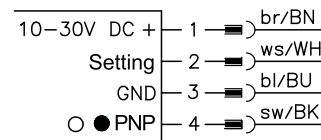
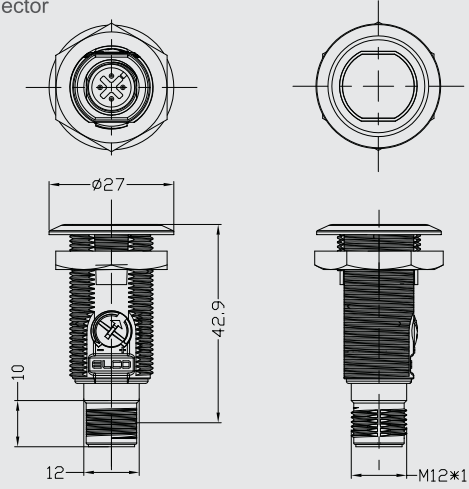

Fig.6

Dimensions:

M12 connector



2m cable

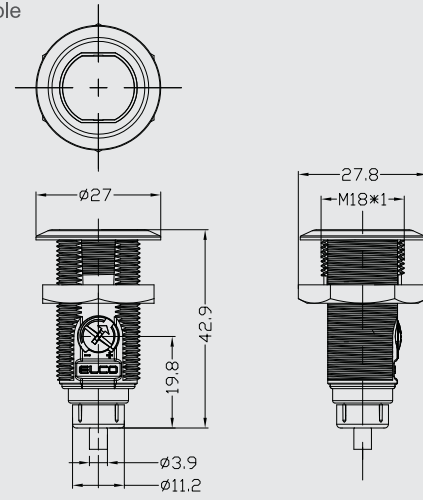

Mounting bracket (standard):

EOG18-1

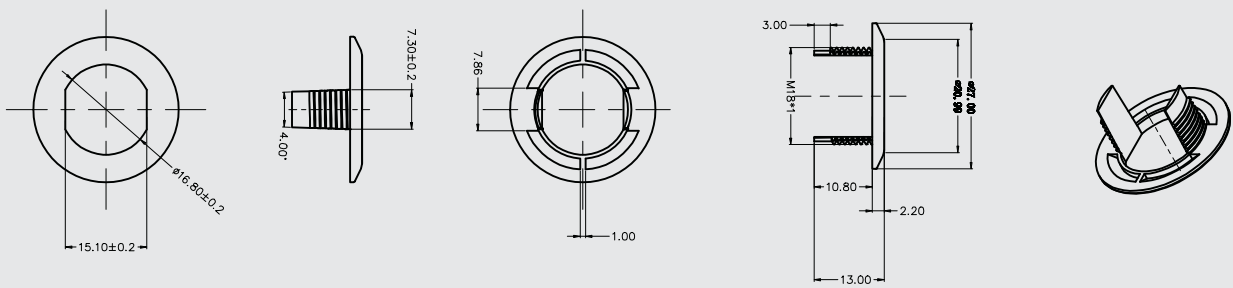

Reflector (optional):

RB50x50-1

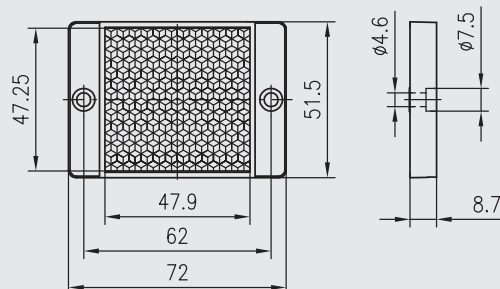

Photoelectric Sensors—Compact-OSQ18



Description:

Optional mounting methods: mounting hole for barrel series or screw for rectangular series, 30m long distance opposed, laser beam products. Set the distance BGS type products have excellent black and white attenuation characteristics, Suitable for automotive parts, packaging, logistics transportation, metal processing and others.

Features:

- Compact size
- Long sensing range
- Visible red beam, laser beam

Sensor function description:

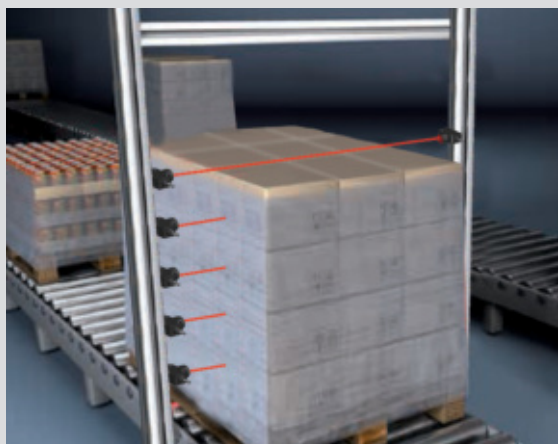

The laser beam opposed, the ultra-fine spot does not diverge. Close mounting does not interfere with each other. Multiple pairs of side-by-side mounted sensors measure carton's height which is economical and practical.

Polarized retro-reflective photoelectric sensor is suitable for automotive, metal processing, printing and other industries, can stably detect highly reflective objects.

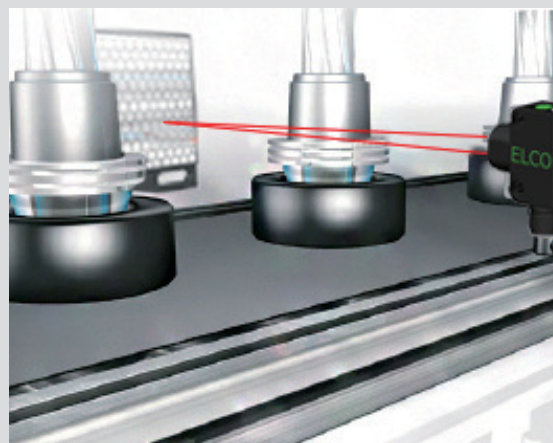

Type:

Detection mode	Type	Distance	Light source	Frequency	Output	Switching mode	Connection	Wiring
Opposed	OSQ18-S6(emitter)	25m	Infrared	---	---	---	2m cable	Fig.1
	OSQ18-EVP6(receiver)		---	800Hz	PNP	NO+NC	2m cable	Fig.3
	OSQ18-EVN6(receiver)		---	800Hz	NPN	NO+NC	2m cable	Fig.4
	OSQ18-S6Q(emitter)	25m	Infrared	---	---	---	M12 connector	Fig.2
	OSQ18-EVP6Q(receiver)		---	800Hz	PNP	NO+NC	M12 connector	Fig.5
	OSQ18-EVN6Q(receiver)		---	800Hz	NPN	NO+NC	M12 connector	Fig.6
	OSQ18-SL306 (emitter)	30m	laser	---	---	---	2m cable	Fig.1
	OSQ18-EL30VP6(receiver)		---	800Hz	PNP	NO+NC	2m cable	Fig.3
	OSQ18-EL30VN6 (receiver)		---	800Hz	NPN	NO+NC	2m cable	Fig.4
	OSQ18-SL306Q(emitter)	30m	laser	---	---	---	M12 connector	Fig.2
	OSQ18-EL30VP6Q(receiver)		---	800Hz	PNP	NO+NC	M12 connector	Fig.5
	OSQ18-EL30VN6Q(receiver)		---	800Hz	NPN	NO+NC	M12 connector	Fig.6

Retro-reflective	OSQ18-RVP6	3.5m	Red	800Hz	PNP	NO+NC	2m cable	Fig.3
	OSQ18-RVN6	3.5m	Red	800Hz	NPN	NO+NC	2m cable	Fig.4
	OSQ18-RVP6Q	3.5m	Red	800Hz	PNP	NO+NC	M12 connector	Fig.5
	OSQ18-RVN6Q	3.5m	Red	800Hz	NPN	NO+NC	M12 connector	Fig.6
Polarized retro-reflective	OSQ18-RPVP6	3.5m	Red	800Hz	PNP	NO+NC	2m cable	Fig.3
	OSQ18-RPVN6	3.5m	Red	800Hz	NPN	NO+NC	2m cable	Fig.4
	OSQ18-RPVP6Q	3.5m	Red	800Hz	PNP	NO+NC	M12 connector	Fig.5
	OSQ18-RPVN6Q	3.5m	Red	800Hz	NPN	NO+NC	M12 connector	Fig.6

Diffused	OSQ18-K200VP6	200mm	Red	800Hz	PNP	NO+NC	2m cable	Fig.7
	OSQ18-K200VN6	200mm	Red	800Hz	NPN	NO+NC	2m cable	Fig.8
	OSQ18-K200VP6Q	200mm	Red	800Hz	PNP	NO+NC	M12 connector	Fig.9
	OSQ18-K200VN6Q	200mm	Red	800Hz	NPN	NO+NC	M12 connector	Fig.10
	OSQ18-K400VP6	400mm	Red	800Hz	PNP	NO+NC	2m cable	Fig.7
	OSQ18-K400VN6	400mm	Red	800Hz	NPN	NO+NC	2m cable	Fig.8
	OSQ18-K400VP6Q	400mm	Red	800Hz	PNP	NO+NC	M12 connector	Fig.9
	OSQ18-K400VN6Q	400mm	Red	800Hz	NPN	NO+NC	M12 connector	Fig.10
	OSQ18-K600VP6	600mm	Red	800Hz	PNP	NO+NC	2m cable	Fig.7
	OSQ18-K600VN6	600mm	Red	800Hz	NPN	NO+NC	2m cable	Fig.8
	OSQ18-K600VP6Q	600mm	Red	800Hz	PNP	NO+NC	M12 connector	Fig.9
	OSQ18-K600VN6Q	600mm	Red	800Hz	NPN	NO+NC	M12 connector	Fig.10

Photoelectric Sensors—Compact-OSQ18

Detection mode	Type	Distance	Light source	Frequency	Output	Switching mode	Connection	Wiring
BGS	OSQ18-AK50VP6	5...50mm	Red	800Hz	PNP	NO+NC	2m cable	Fig.7
	OSQ18-AK50VN6	5...50mm	Red	800Hz	NPN	NO+NC	2m cable	Fig.8
	OSQ18-AK50VP6Q	5...50mm	Red	800Hz	PNP	NO+NC	M12 connector	Fig.9
	OSQ18-AK50VN6Q	5...50mm	Red	800Hz	NPN	NO+NC	M12 connector	Fig.10
	OSQ18-AK100VP6	8...100mm	Red	800Hz	PNP	NO+NC	2m cable	Fig.7
	OSQ18-AK100VN6	8...100mm	Red	800Hz	NPN	NO+NC	2m cable	Fig.8
	OSQ18-AK100VP6Q	8...100mm	Red	800Hz	PNP	NO+NC	M12 connector	Fig.9
	OSQ18-AK100VN6Q	8...100mm	Red	800Hz	NPN	NO+NC	M12 connector	Fig.10
	OSQ18-AK150VP6	10...150mm	Red	800Hz	PNP	NO+NC	2m cable	Fig.7
	OSQ18-AK150VN6	10...150mm	Red	800Hz	NPN	NO+NC	2m cable	Fig.8
	OSQ18-AK150VP6Q	10...150mm	Red	800Hz	PNP	NO+NC	M12 connector	Fig.9
	OSQ18-AK150VN6Q	10...150mm	Red	800Hz	NPN	NO+NC	M12 connector	Fig.10
	OSQ18-AK200VP6	10...200mm	Red	800Hz	PNP	NO+NC	2m cable	Fig.7
	OSQ18-AK200VN6	10...200mm	Red	800Hz	NPN	NO+NC	2m cable	Fig.8
	OSQ18-AK200VP6Q	10...200mm	Red	800Hz	PNP	NO+NC	M12 connector	Fig.9
	OSQ18-AK200VN6Q	10...200mm	Red	800Hz	NPN	NO+NC	M12 connector	Fig.10

Technical Data:

Operating voltage	10...30VDC
Ripple voltage	≤10%
No-load current	Opposed: ≤25mA; Others: ≤15mA
Load current	≤200mA
Black and white attenuation	< 3mm(AK50); < 10mm(AK100); < 15mm(AK150)
Spot size	5mm(AK50); 8mm(AK100); 10mm(AK150)
Protective circuit	Reverse polarity protection, short circuit protection, Overload protection
Sensitivity	Adjustable, with single-turn knob
Output indicator	Red LED
Steady state indicator	Green LED
Ambient temperature	-25...55°C
Storage temperature	-40...70°C
Voltage resistance	1000V/AC 50/60Hz 60s
Insulation impedance	≥50MΩ(500VDC)
Shock resistance	Complex amplitude 1.5mm 10... 50Hz (2hr X, Y,Z respectively)
Impact resistance	500m/S ² (50G) 3 times X,Y,Z respectively
Protection class	IP67
Housing material	PBT+ABS

Wiring:

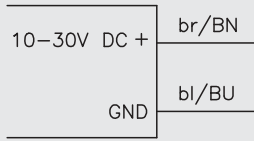

Fig.1

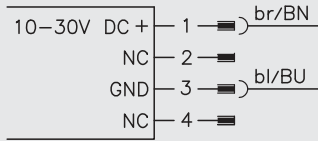

Fig.2

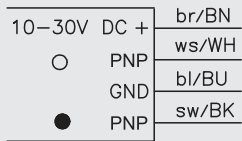

Fig.3

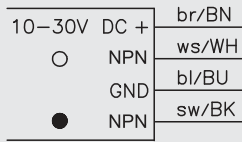

Fig.4

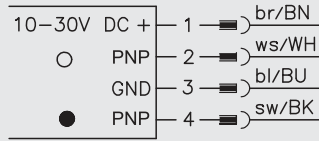

Fig.5

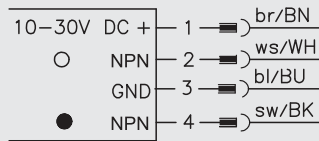

Fig.6

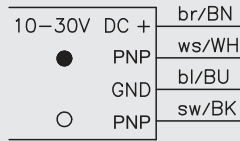

Fig.7

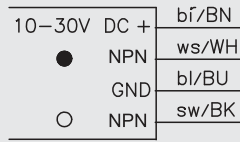

Fig.8

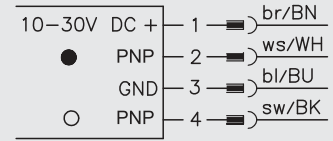

Fig.9

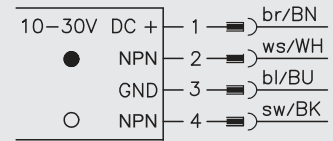
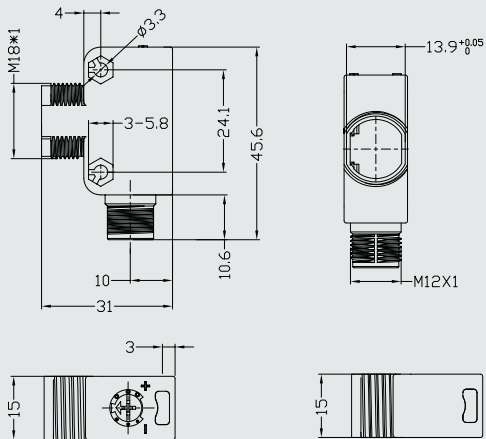

Fig.10

Dimensions:

M12 connector



2m cable

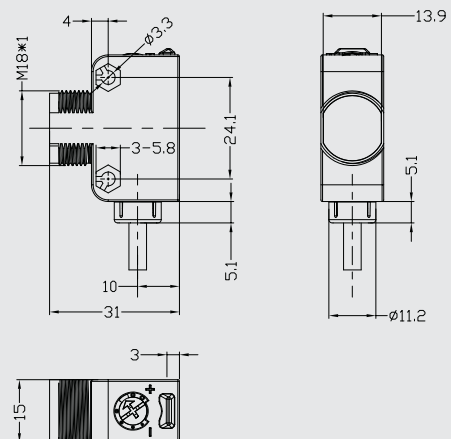

Reflector (optional):

RB50x50-1

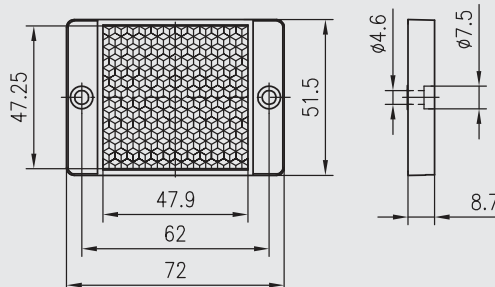

Photoelectric Sensors—Mini-OS21



Description:

The compact design is very suitable for limited mounting space requirement in electronic, semiconductor and other industries. BGS products have excellent black-and-white attenuation characteristics, suitable for detecting non-bright surface objects, minimum detectable 0.2mm copper wire.

Features:

- AK30 product can stably detect transparent glass bottles
- Spot light source, divergent light with small-angle
- Mounting hole $\Phi 3$, built-in metal parts, strong and long life-time

Type:

Detection mode	Type	Distance	Light source	Frequency	Output	Switching mode	Connection	Wiring
Opposed	OS21-S6 (emitter)	1m	Infrared	---	---	---	2m cable	Fig.1
	OS21-ELN6 (receiver)		---	800Hz	NPN	Light on	2m cable	Fig.2
	OS21-EDN6 (receiver)		---	800Hz	NPN	Dark on	2m cable	Fig.3
	OS21-S6 (emitter)	1m	Infrared	---	---	---	2m cable	Fig.1
	OS21-ELP6 (receiver)		---	800Hz	PNP	Light on	2m cable	Fig.4
	OS21-EDP6 (receiver)		---	800Hz	PNP	Dark on	2m cable	Fig.5
	OS21-S26 (emitter)	2m	Infrared	---	---	---	2m cable	Fig.1
	OS21-E2LN6 (receiver)		---	800Hz	NPN	Light on	2m cable	Fig.2
	OS21-E2DN6 (receiver)		---	800Hz	NPN	Dark on	2m cable	Fig.3
	OS21-S26 (emitter)	2m	Infrared	---	---	---	2m cable	Fig.1
	OS21-E2LP6 (receiver)		---	800Hz	PNP	Light on	2m cable	Fig.4
	OS21-E2DP6 (receiver)		---	800Hz	PNP	Dark on	2m cable	Fig.5
BGS	OS21-AK15LN6	4...15mm	Red	800Hz	NPN	Light on	2m cable	Fig.2
	OS21-AK15DN6		Red	800Hz	NPN	Dark on	2m cable	Fig.3
	OS21-AK15LP6		Red	800Hz	PNP	Light on	2m cable	Fig.4
	OS21-AK15DP6		Red	800Hz	PNP	Dark on	2m cable	Fig.5
	OS21-AK30LN6	5...30mm	Red	800Hz	NPN	Light on	2m cable	Fig.2
	OS21-AK30DN6		Red	800Hz	NPN	Dark on	2m cable	Fig.3
	OS21-AK30LP6		Red	800Hz	PNP	Light on	2m cable	Fig.4
	OS21-AK30DP6		Red	800Hz	PNP	Dark on	2m cable	Fig.5
	OS21-AK50LN6	5...50mm	Red	800Hz	NPN	Light on	2m cable	Fig.2
	OS21-AK50DN6		Red	800Hz	NPN	Dark on	2m cable	Fig.3
	OS21-AK50LP6		Red	800Hz	PNP	Light on	2m cable	Fig.4
	OS21-AK50DP6		Red	800Hz	PNP	Dark on	2m cable	Fig.5

Technical Data:

Operating voltage	10...30VDC
Ripple voltage	≤10%
Output type	PNP/NPN (Depends on the model)
Output feature	Light on/dark on (Depends on the model)
No-load current	≤20mA
load current	<100mA
Black and white attenuation	< 2mm(AK15、 AK30); < 8mm(AK50)
Spot size	5mm(AK15); 6mm(AK30); 8mm(AK50)
Light source	Red, Infrared
Output indicator	Yellow LED
Steady state indicator	Green LED
Housing material	PC+ABS
Lens material	PMM4
Protection class	IP67
Ambient temperature	-20...+50°C
Storage temperature	-40...+70°C
Circuit protection	Reverse polarity protection, short circuit protection, Overload protection, voltage shock protection
Voltage withstanding	1000V/AC 50/60Hz 60s
Insulation impedance	≥50MΩ(500VDC)
Shock resistance	Complex amplitude 1.5mm 10... 50Hz (2hr X, Y,Z respectively)
Impact resistance	500m/S ² (50G) 3 times X,Y,Z respectively

Wiring:

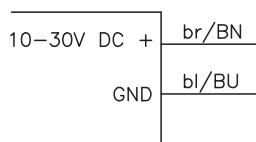

Fig.1

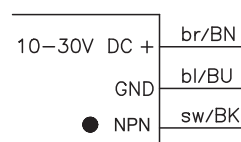

Fig.3

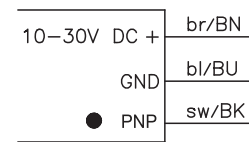

Fig.5

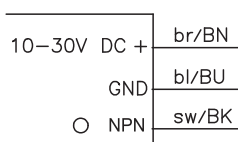

Fig.2

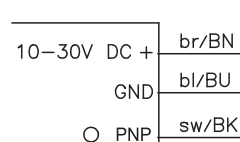
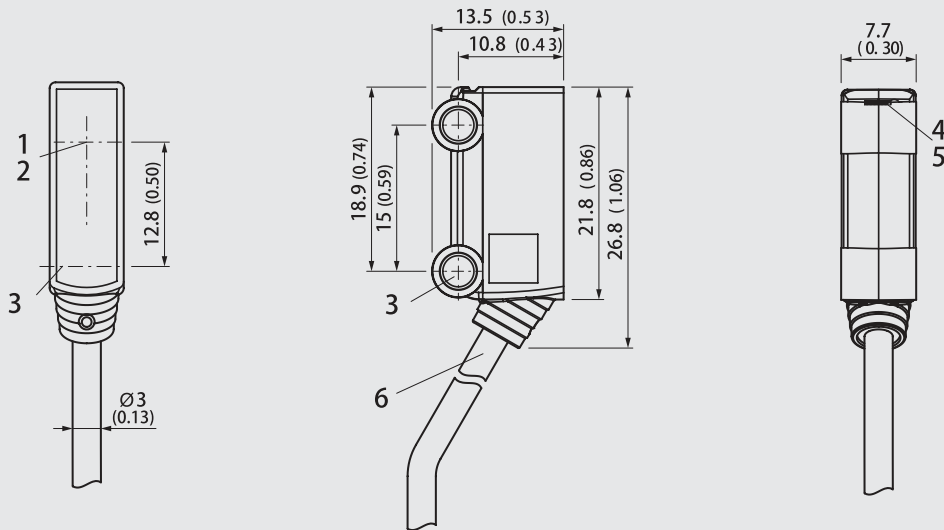

Fig.4

Dimensions:



1	Receiver optic axis
2	Emitter optic axis
3	Mounting hole $\varnothing 3.2\text{mm}$
4	Green LED indicator: power on
5	Yellow LED indicator: receive light
6	Connection: cable connection



Description:

Mini-rectangular photoelectric sensors OS10 series, with high performance and 25.4mm standard mounting hole distance, are available as BGS (background suppression) mode, Diffused mode, retro-reflective mode, and opposed mode. With optional red beam or laser beam source, they are suitable for Mask machine, ATM machine, logistics transportation, new energy and other application fields.

Features:

- BGS function greatly improves the detection effect
- Optional red beam or laser beam
- Adjustable sensing range
- Protection class IP67
- Optional M8 connector, 2 m pre-wired cable

Type:

Detection mode	Type	Distance	Light source	Frequency	Output	Switching mode	Connection	Wiring
Opposed	OS10-S6 (emitter)	30m	Infrared	---	---	---	2m cable	Fig. 1
	OS10-ECN6(receiver)		---	800Hz	NPN	Light on/dark on	2m cable	Fig. 2
	OS10-ECP6(receiver)		---	800Hz	PNP	Light on/dark on	2m cable	Fig. 3
	OS10-S6Q8(emitter)	30m	Infrared	---	---	---	M8 connector, 4-pin	Fig. 4
	OS10-ECN6Q8(receiver)		---	800Hz	NPN	Light on/dark on	M8 connector, 4-pin	Fig. 5
	OS10-ECP6Q8(receiver)		---	800Hz	PNP	Light on/dark on	M8 connector, 4-pin	Fig. 6
Polarized retro-reflective	OS10-RPCN6	3m	Red	800Hz	NPN	Light on/dark on	2m cable	Fig. 2
	OS10-RPCP6	3m	Red	800Hz	PNP	Light on/dark on	2m cable	Fig. 3
	OS10-RPCN6Q8	3m	Red	800Hz	NPN	Light on/dark on	M8 connector, 4-pin	Fig. 5
	OS10-RPCP6Q8	3m	Red	800Hz	PNP	Light on/dark on	M8 connector, 4-pin	Fig. 6
Diffused	OS10-K1000CN6	20...1000mm	Red	800Hz	NPN	Light on/dark on	2m cable	Fig. 2
	OS10-K1000CP6	20...1000mm	Red	800Hz	PNP	Light on/dark on	2m cable	Fig. 3
	OS10-K1000CN6Q8	20...1000mm	Red	800Hz	NPN	Light on/dark on	M8 connector, 4-pin	Fig. 5
	OS10-K1000CP6Q8	20...1000mm	Red	800Hz	PNP	Light on/dark on	M8 connector, 4-pin	Fig. 6
BGS	OS10-AK65CN6	6...65mm	Red	500Hz	NPN	Light on/dark on	2m cable	Fig. 2
	OS10-AK65CP6	6...65mm	Red	500Hz	PNP	Light on/dark on	2m cable	Fig. 3
	OS10-AK65CN6Q8	6...65mm	Red	500Hz	NPN	Light on/dark on	M8 connector, 4-pin	Fig. 5
	OS10-AK65CP6Q8	6...65mm	Red	500Hz	PNP	Light on/dark on	M8 connector, 4-pin	Fig. 6
	OS10-AK150CN6	6...150mm	Red	500Hz	NPN	Light on/dark on	2m cable	Fig. 2
	OS10-AK150CP6	6...150mm	Red	500Hz	PNP	Light on/dark on	2m cable	Fig. 3
	OS10-AK150CN6Q8	6...150mm	Red	500Hz	NPN	Light on/dark on	M8 connector, 4-pin	Fig. 5
	OS10-AK150CP6Q8	6...150mm	Red	500Hz	PNP	Light on/dark on	M8 connector, 4-pin	Fig. 6
	OS10-AK350CN6	6...350mm	Red	500Hz	NPN	Light on/dark on	2m cable	Fig. 2
	OS10-AK350CP6	6...350mm	Red	500Hz	PNP	Light on/dark on	2m cable	Fig. 3
	OS10-AK350CN6Q8	6...350mm	Red	500Hz	NPN	Light on/dark on	M8 connector, 4-pin	Fig. 5
	OS10-AK350CP6Q8	6...350mm	Red	500Hz	PNP	Light on/dark on	M8 connector, 4-pin	Fig. 6

Type:

Detection mode	Type	Distance	Light source	Frequency	Output	Switching mode	Connection	Wiring
Opposed	OS10-SL6 (emitter)	30m	Laser	---	---	---	2m cable	Fig. 1
	OS10-ELCN6(receiver)		---	800Hz	NPN	Light on/dark on	2m cable	Fig. 2
	OS10-ELCP6(receiver)		---	800Hz	PNP	Light on/dark on	2m cable	Fig. 3
	OS10-SL6Q8 (emitter)	30m	Laser	---	---	---	M8 connector, 4-pin	Fig. 4
	OS10-ELCN6Q8 (receiver)		---	800Hz	NPN	Light on/dark on	M8 connector, 4-pin	Fig. 5
	OS10-ELCP6Q8 (receiver)		---	800Hz	PNP	Light on/dark on	M8 connector, 4-pin	Fig. 6
Polarized retro-reflective	OS10-RPLCN6	5m	Laser	800Hz	NPN	Light on/dark on	2m cable	Fig. 2
	OS10-RPLCP6	5m	Laser	800Hz	PNP	Light on/dark on	2m cable	Fig. 3
	OS10-RPLCN6Q8	5m	Laser	800Hz	NPN	Light on/dark on	M8 connector, 4-pin	Fig. 5
	OS10-RPLCP6Q8	5m	Laser	800Hz	PNP	Light on/dark on	M8 connector, 4-pin	Fig. 6
BGS	OS10-AKL150CN6	6...150mm	Laser	500Hz	NPN	Light on/dark on	2m cable	Fig. 2
	OS10-AKL150CP6	6...150mm	Laser	500Hz	PNP	Light on/dark on	2m cable	Fig. 3
	OS10-AKL150CN6Q8	6...150mm	Laser	500Hz	NPN	Light on/dark on	M8 connector, 4-pin	Fig. 5
	OS10-AKL150CP6Q8	6...150mm	Laser	500Hz	PNP	Light on/dark on	M8 connector, 4-pin	Fig. 6
	OS10-AKL350CN6	6...350mm	Laser	500Hz	NPN	Light on/dark on	2m cable	Fig. 2
	OS10-AKL350CP6	6...350mm	Laser	500Hz	PNP	Light on/dark on	2m cable	Fig. 3
	OS10-AKL350CN6Q8	6...350mm	Laser	500Hz	NPN	Light on/dark on	M8 connector, 4-pin	Fig. 5
	OS10-AKL350CP6Q8	6...350mm	Laser	500Hz	PNP	Light on/dark on	M8 connector, 4-pin	Fig. 6

Technical Data:

Operating voltage	10...30VDC
Ripple voltage	≤10%
Light source	Red (625nm) / class 1 laser
Output type	PNP / NPN
Switch mode	Light on: Setting connects U+ Dark on: Setting connects U-
No-load current	≤20mA
load current	≤100mA
Sensitivity	Potentiometer adjustment
Output indicator	Red LED
Steady state indicator	Green LED
Housing	PC+PBT
Connection	M8 connector/2m cable
Ambient temperature	-25°C...+55°C
Storage temperature	-40°C...+70°C
Protection class	IP67
Voltage withstanding	1000V/AC 50/60Hz 60s
Insulation impedance	≥50MΩ(500VDC)
Shock resistance	Complex amplitude 1.5mm 10... 50Hz (2hr X, Y,Z respectively)
Impact resistance	500m/S ² (50G) 3 times X,Y,Z respectively

Product Features:

<p>Precise distance setting High resolution</p>	<p>Multi-turn potentiometer for accurate setting. Detect a workpiece with a thickness of up to 0.2 mm, such as a business card (the object to be tested is standard white).</p>	
<p>BGS function</p>	<p>For workpieces of different colors and materials, the detection distance is basically the same. For a whiteboard with a reflectivity of 90% and a blackboard with a reflectivity of 6%, the distance attenuation is within 15%.</p>	<p>Attenuation rate Y</p> <p>Distance (white matte paper 90%) X (mm)</p>
<p>Small spot</p>	<p>The OS10-AKL150 series laser light source has a spot size of 1mm at 100mm position, which has the advantages of precise positioning and edge detection.</p>	
<p>High brightness light source</p>	<p>High-brightness LED red light source for easy identification of detection positions</p> <div style="display: flex; justify-content: space-around;"> <div data-bbox="508 913 922 1311"> <p>Distance Y (mm)</p> <p>Beam size X (mm)</p> <p>OS10-AK150</p> </div> <div data-bbox="946 913 1377 1311"> <p>Distance Y (mm)</p> <p>Beam size X (mm)</p> <p>OS10-AK350</p> </div> </div>	
<p>BGS</p>	<p>Distance (mm)</p> <p>Potentiometer angle (degree)</p> <p>OS10-AK150/AKL150</p>	<p>Distance (mm)</p> <p>Potentiometer angle (degree)</p> <p>OS10-AK350/AKL350</p>
<p>Resolution</p>	<p>resolution (mm)</p> <p>distance (mm)</p> <p>AK150</p>	<p>resolution (mm)</p> <p>distance (mm)</p> <p>AK350</p>

BGS - Background Suppression Function:

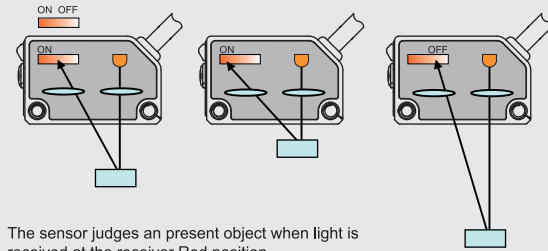

The sensor judges an present object when light is received at the receiver Red position.

Standard diffused mode photoelectric sensors detect the objects according to the value of the received light, which is dependent on object color, material, transparency and other factors. Therefore, even using the same type of diffused photoelectric sensor to detect different objects, the sensing ranges vary dramatically.

By using dual diode receiver, the BGS mode photoelectric sensors detect the objects according to the different position that reflected light falls on the receiver. As shown in left figure, when the sensor is relatively close to the object, the reflected light falls on receiver Red position, at this time, the output is turned ON.

The sensing range of the photoelectric sensors with BGS is basically the same for various objects.

Laser polarizer reverse operation guide:

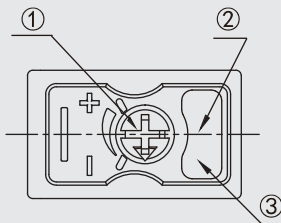

Potentiometer	
Output indicator	Red LED
Stable indicator	Green LED

1. When the sensitivity is minimum, there is no response to the reflector or highlight objects.

2. Place the reflector to the demanding position, slowly increase the sensitivity from the minimum, still the red and green LEDs are both on, and the setting is completed.

3. When the sensitivity is maximum, if the product is triggered by the highlight object, the sensitivity need to be reduced till the red and green LEDs just turn on.

Wiring:

Cable

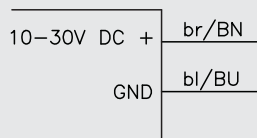

Fig.1

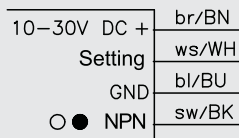

Fig.2

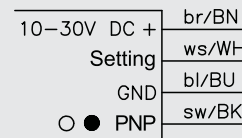

Fig.3

M8 connector

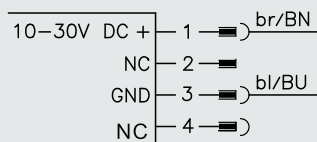

Fig.4

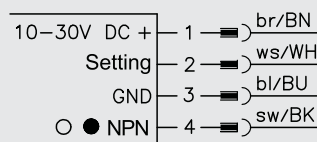

Fig.5

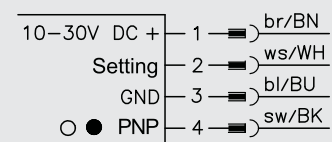
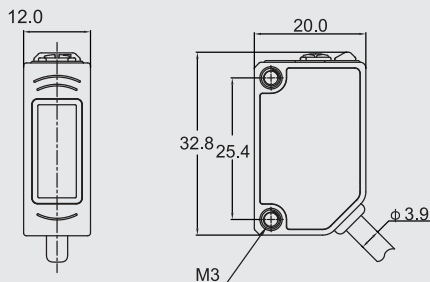

Fig.6

Dimensions:

Cable



M8 connector

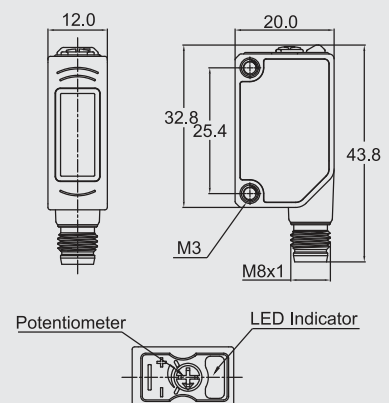



Description:

High-performance mini rectangular photoelectric sensor can provide BGS (dynamic and static state, 1M BGS) detection, laser coaxial polarized retro-reflective detection and laser non-coaxial polarized retro-reflective detection, transparent object detection and PCB detection. It is suitable for logistics, Textile, glass machinery, food packaging and other applications.

Features:

- It can provide stable and reliable detection of the motion state of objects
- Distance of 1M available for BGS
- Coaxial has no blind-zone, precise positioning function
- Red or laser are optional

Type:

Detection mode	Type	Distance	Light source	Frequency	Output	Switching mode	Connection	Wiring
Dynamic and static state	OS20-SDK40CN6	40mm	Red	800Hz	NPN	Light on/dark on	2m cable	Fig.1
	OS20-SDK40CP6		Red	800Hz	PNP	Light on/dark on	2m cable	Fig.3
	OS20-SDK40CN6Q8		Red	800Hz	NPN	Light on/dark on	M8 4-pin connector	Fig.2
	OS20-SDK40CP6Q8		Red	800Hz	PNP	Light on/dark on	M8 4-pin connector	Fig.4
BGS PCB detection line array light source	OS20-AK100CN6/L	100mm	Red	800Hz	NPN	Light on/dark on	2m cable	Fig.1
	OS20-AK100CP6/L		Red	800Hz	PNP	Light on/dark on	2m cable	Fig.3
	OS20-AK100CN6Q8/L		Red	800Hz	NPN	Light on/dark on	M8 4-pin connector	Fig.2
	OS20-AK100CP6Q8/L		Red	800Hz	PNP	Light on/dark on	M8 4-pin connector	Fig.4
BGS	OS20-AK300CN6	6...300mm	Red	800Hz	NPN	Light on/dark on	2m cable	Fig.1
	OS20-AK300CP6		Red	800Hz	PNP	Light on/dark on	2m cable	Fig.3
	OS20-AK300CN6Q8		Red	800Hz	NPN	Light on/dark on	M8 4-pin connector	Fig.2
	OS20-AK300CP6Q8		Red	800Hz	PNP	Light on/dark on	M8 4-pin connector	Fig.4
BGS	OS20-AK1000CN6	20...1000mm	Red	30Hz	NPN	Light on/dark on	2m cable	Fig.1
	OS20-AK1000CP6		Red	30Hz	PNP	Light on/dark on	2m cable	Fig.3
	OS20-AK1000CN6Q8		Red	30Hz	NPN	Light on/dark on	M8 4-pin connector	Fig.2
	OS20-AK1000CP6Q8		Red	30Hz	PNP	Light on/dark on	M8 4-pin connector	Fig.4
Retro-reflective transparent object detection	OS20-TRCN6	2.5m	Red	50Hz	NPN	Light on/dark on	2m cable	Fig.1
	OS20-TRCP6		Red	50Hz	PNP	Light on/dark on	2m cable	Fig.3
	OS20-TRCN6Q8		Red	50Hz	NPN	Light on/dark on	M8 4-pin connector	Fig.2
	OS20-TRCP6Q8		Red	50Hz	PNP	Light on/dark on	M8 4-pin connector	Fig.4
Non-coaxial polarized retro-reflective detection	OS20-RPLCN6	5m	Laser	800Hz	NPN	Light on/dark on	2m cable	Fig.1
	OS20-RPLCP6		Laser	800Hz	PNP	Light on/dark on	2m cable	Fig.3
	OS20-RPLCN6Q8		Laser	800Hz	NPN	Light on/dark on	M8 4-pin connector	Fig.2
	OS20-RPLCP6Q8		Laser	800Hz	PNP	Light on/dark on	M8 4-pin connector	Fig.4
Coaxial polarized retro-reflective detection	OS20-TRPLCN6	5m	Laser	800Hz	NPN	Light on/dark on	2m cable	Fig.1
	OS20-TRPLCP6		Laser	800Hz	PNP	Light on/dark on	2m cable	Fig.3
	OS20-TRPLCN6Q8		Laser	800Hz	NPN	Light on/dark on	M8 4-pin connector	Fig.2
	OS20-TRPLCP6Q8		Laser	800Hz	PNP	Light on/dark on	M8 4-pin connector	Fig.4

*I Infrared beam, eg. OS20-AK100CN6/L/I

Technical Data:

Operating voltage	10...30VDC
Ripple voltage	≤10%
Light source	Red (625nm) / class 1 laser
Output type	PNP / NPN
Switch mode	Light on: Setting connects U+ Dark on: Setting connects U-
No-load current	≤20mA
load current	≤100mA
Sensitivity	Teach button or potentiometer adjustment
Output indicator	Red LED
Steady state indicator	Green LED
Housing	PC+PBT
Connection	M8 connector/2m cable
Ambient temperature	-25°C...+55°C
Storage temperature	-40°C...+70°C
Voltage withstanding	1000V/AC/ 50/60Hz 60s
Insulation impedance	≥50MΩ (500VDC)
Shock resistance	Complex amplitude 1.5mm 10... 50Hz (2hr X, Y,Z respectively)
Impact resistance	500m/S ² (50G) 3 times X,Y,Z respectively
Protection class	IP67

Wiring:

Pre-wired cable

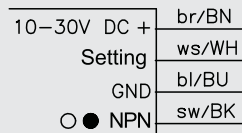

Fig.1

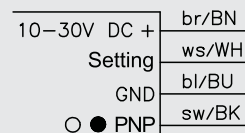

Fig.2

M8 connector

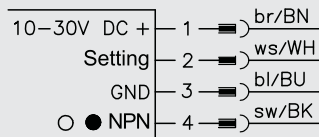

Fig.3

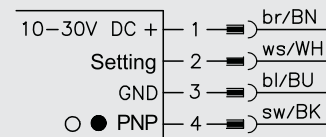
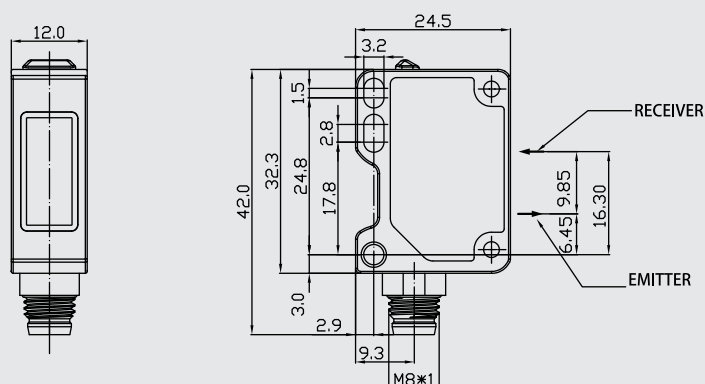

Fig.4

Dimensions:





Description:

Cost-effective product, compact structure (20x32x12mm), 360° LED indicator, small size with reliable detection. Suitable for applications such as gates, logistics, printing, packaging, etc.

Features:

- Potentiometer adjustment
- Distance of 200mm and 400mm available for diffused
- Anti-interference capability
- M8 Pigtail connection optional
- Infrared beam, */R optional for red beam

Type:

Detection mode	Type	Distance	Light source	Frequency	Output	Switching mode	Connection	Wiring
Opposed	OS12-S6(emitter)	10m	Infrared	---	---	---	2m cable	Fig.1
	OS12-ECN6(receiver)		---	800Hz	NPN	Light on/dark on	2m cable	Fig.3
	OS12-ECP6(receiver)		---	800Hz	PNP	Light on/dark on	2m cable	Fig.4
	OS12-S6-*-Q8(emitter)	10m	Infrared	---	---	---	M8 Pigtail	Fig.2
	OS12-ECN6-*-Q8(receiver)		---	800Hz	NPN	Light on/dark on	M8 Pigtail	Fig.5
	OS12-ECP6-*-Q8(receiver)		---	800Hz	PNP	Light on/dark on	M8 Pigtail	Fig.6
Reflector	OS12-RCN6	3m	Infrared	800Hz	NPN	Light on/dark on	2m cable	Fig.3
	OS12-RCP6	3m	Infrared	800Hz	PNP	Light on/dark on	2m cable	Fig.4
	OS12-RCN6-*-Q8	3m	Infrared	800Hz	NPN	Light on/dark on	M8 Pigtail	Fig.5
	OS12-RCP6-*-Q8	3m	Infrared	800Hz	PNP	Light on/dark on	M8 Pigtail	Fig.6
Diffused (20...400mm)	OS12-K400CN6	400m	Infrared	800Hz	NPN	Light on/dark on	2m cable	Fig.3
	OS12-K400CP6	400m	Infrared	800Hz	PNP	Light on/dark on	2m cable	Fig.4
	OS12-K400CN6-*-Q8	400m	Infrared	800Hz	NPN	Light on/dark on	M8 Pigtail	Fig.5
	OS12-K400CP6-*-Q8	400m	Infrared	800Hz	PNP	Light on/dark on	M8 Pigtail	Fig.6

* Cable length, m, eg. OS12-S6-0.1-Q8, pigtail cable length 0.1m.

*/R red beam, eg. OS12-S6/R

Photoelectric Sensors—Rectangular-OS12

Technical Data:

Operating voltage	10...30VDC
Ripple voltage	≤10%
Light source	Infrared and red are optional
Output type	PNP / NPN
Output feature	Light on/dark on
No-load current	≤20mA
load current	≤100mA
Sensitivity	Adjustable
Spot diameter	1.2m (10m, opposed), 350mm (3m, retro-reflective), 40mm (400mm, diffused)
Output indicator	Yellow LED
Steady state indicator	Green LED
Housing	PC+PBT
Adjustment mode	Single-turn potentiometer
Connection	M8 Pigtail/2m cable
Ambient temperature	-25°C...+55°C
Storage temperature	-40°C...+70°C
Protection class	IP65
Switch mode	Light on: Setting connects U+ Dark on: Setting connects U-

Wiring:

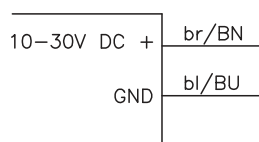

Fig.1

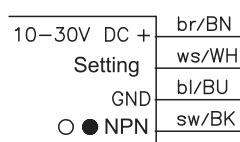

Fig.3

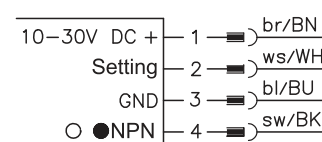

Fig.5

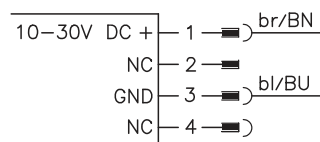

Fig.2

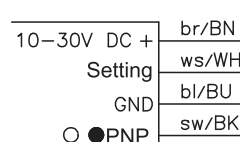

Fig.4

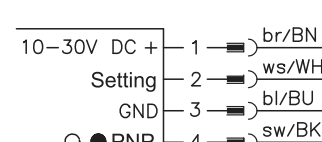
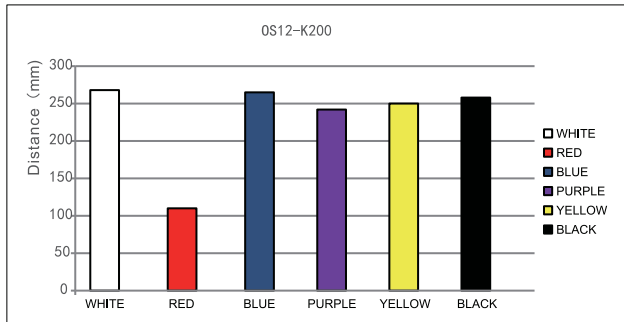

Fig.6

Functional characteristics:

OS12-K200 diffused attenuation figure



OS12-K400 diffused attenuation figure

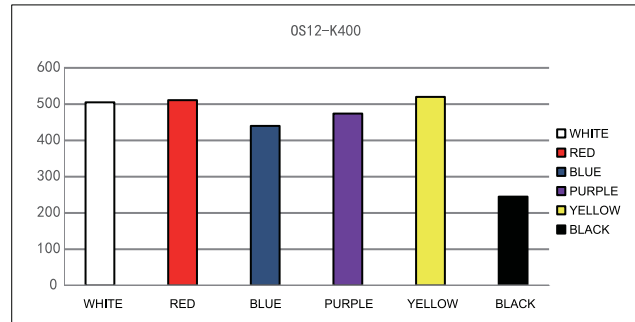

OS12 series characteristic curve

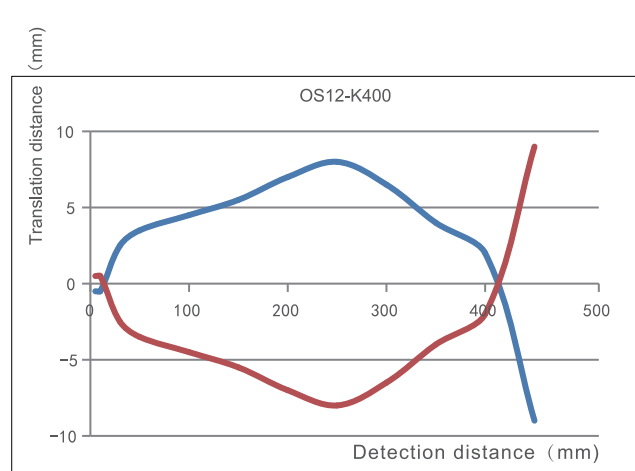
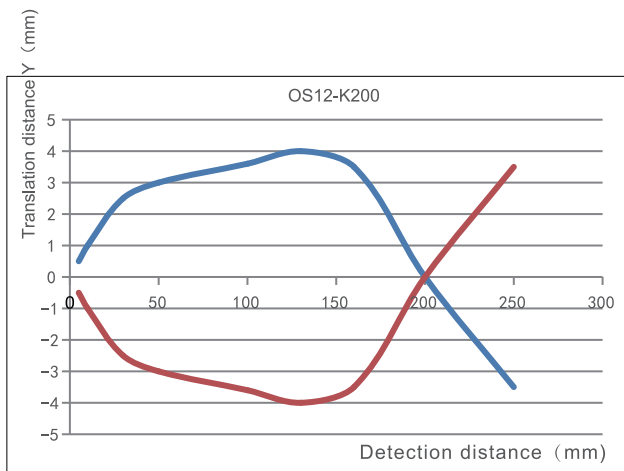
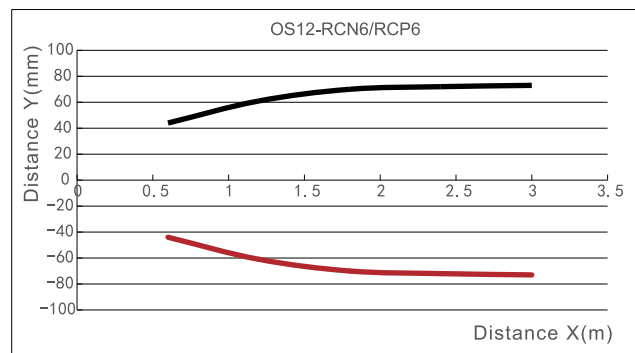
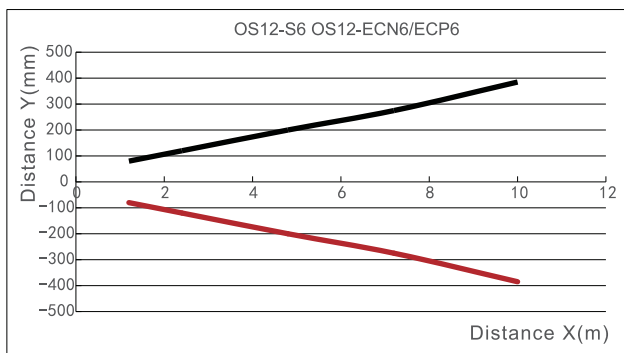

Dimensions:

Pre-wired cable

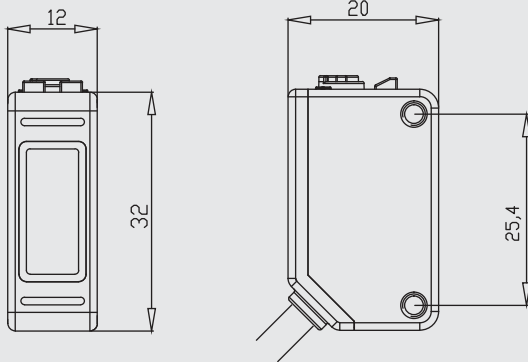

M8 connector

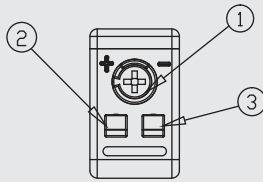
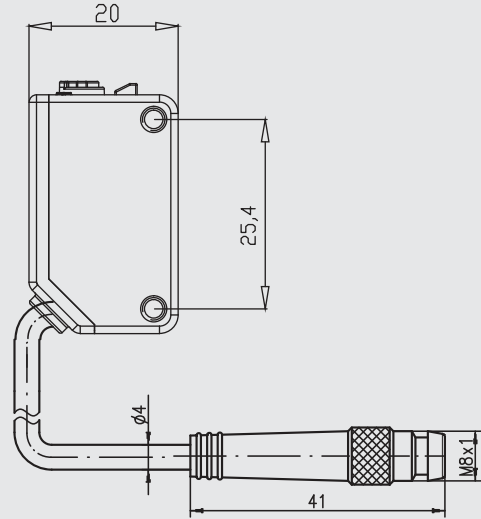

1	Detection distance adjusting knob
2	Power indicator
3	Switch action indicator



Description:

Cost-effective product, compact structure (20x32x12mm), 360° LED indicator, small size with reliable detection. Suitable for applications such as gates, logistics, printing, packaging, etc.

Features:

- Distance of 200mm available for diffused
- Anti-interference capability
- M8 Pigtail connection optional
- Infrared beam, */R optional for red beam
- Detection distance is not adjustable

Type:

Detection mode	Type	Distance	Light source	Frequency	Output	Switching mode	Connection	Wiring
Opposed	OS13-S6(emitter)	10m	Infrared	— —	— —	— —	2m cable	Fig.1
	OS13-ELN6(receiver)		— —	800Hz	NPN	Light on	2m cable	Fig.2
	OS13-EDN6(receiver)		— —	800Hz	NPN	Dark on	2m cable	Fig.3
	OS13-S6(emitter)	10m	Infrared	— —	— —	— —	2m cable	Fig.1
	OS13-ELP6(receiver)		— —	800Hz	PNP	Light on	2m cable	Fig.4
	OS13-EDP6(receiver)		— —	800Hz	PNP	Dark on	2m cable	Fig.5
Reflector	OS13-RLN6	3m	Infrared	800Hz	NPN	Light on	2m cable	Fig.2
	OS13-RLP6	3m	Infrared	800Hz	PNP	Light on	2m cable	Fig.4
	OS13-RDN6	3m	Infrared	800Hz	NPN	Dark on	2m cable	Fig.3
	OS13-RDP6	3m	Infrared	800Hz	PNP	Dark on	2m cable	Fig.5
Diffused (20..200mm)	OS13-K200LN6	200m	Infrared	800Hz	NPN	Light on	2m cable	Fig.2
	OS13-K200LP6	200m	Infrared	800Hz	PNP	Light on	2m cable	Fig.4
	OS13-K200DN6	200m	Infrared	800Hz	NPN	Dark on	2m cable	Fig.3
	OS13-K200DP6	200m	Infrared	800Hz	PNP	Dark on	2m cable	Fig.5

* /R red beam, eg. OS13-S6/R

Photoelectric Sensors—Rectangular-OS13

Technical Data:

Operating voltage	10...30VDC
Ripple voltage	≤10%
Light source	Infrared and red are optional
Output type	PNP / NPN
Output feature	Light on/dark on
No-load current	≤20mA
load current	≤100mA
Spot diameter	1.2m (10m, opposed), 350mm (3m, retro-reflective), 20mm (200mm, diffused)
Output indicator	Yellow LED
Steady state indicator	Green LED
Housing	PC+PBT
Connection	0.1m M8 Pigtail/2m cable
Ambient temperature	-25°C...+55°C
Storage temperature	-40°C...+70°C
Protection class	IP65

Wiring:

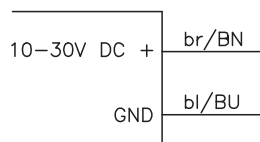

Fig.1

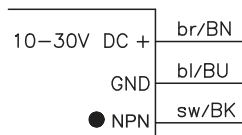

Fig.3

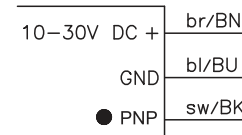

Fig.5

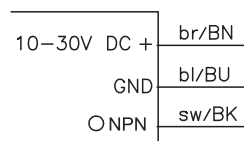

Fig.2

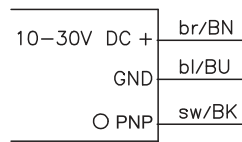
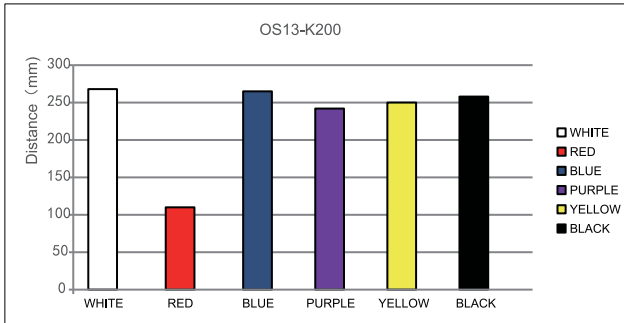

Fig.4

Functional characteristics:

OS13-K200 diffused attenuation figure



OS13-K400 diffused attenuation figure

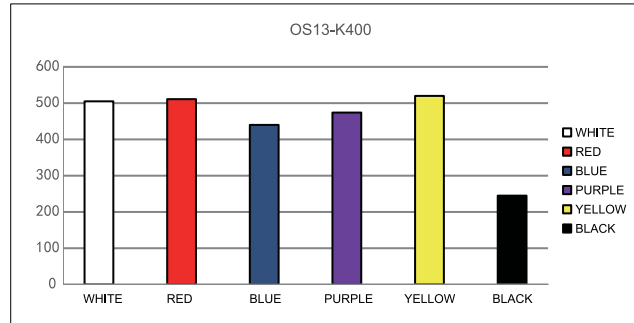

OS13 series characteristic curve

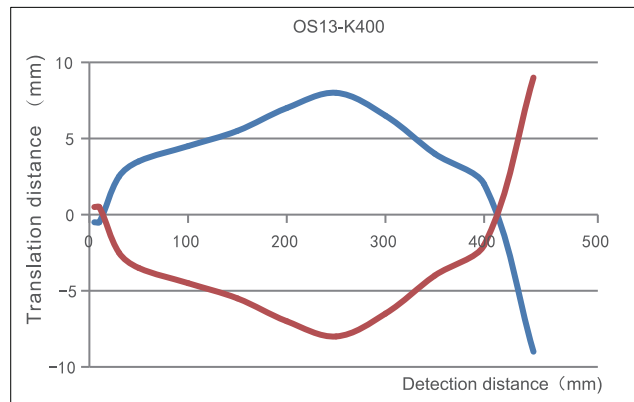
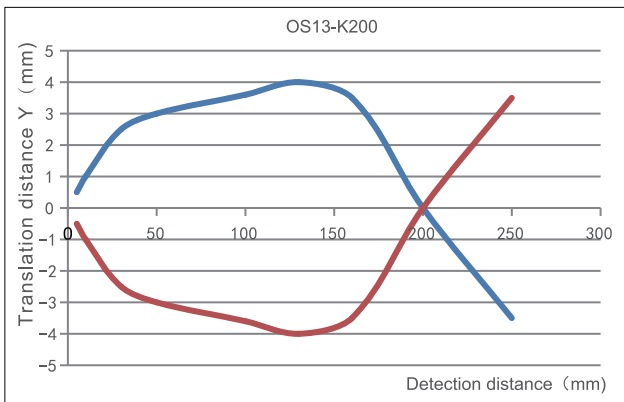
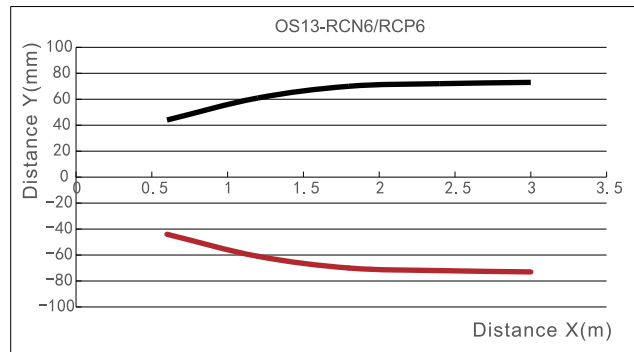
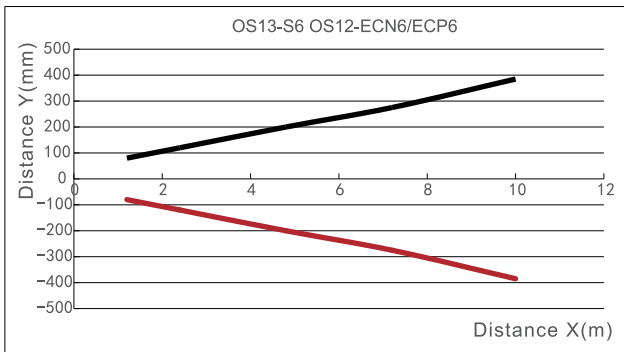

Dimensions:

Pre-wired cable

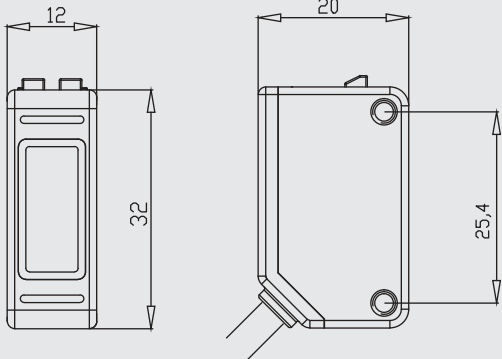

M8 Pigtail

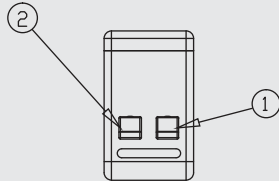
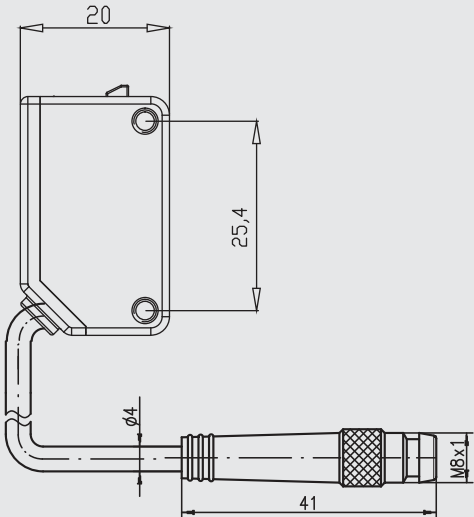

1	Switch action indicator
2	Power indicator



Description:

Rectangular 50*50mm; 40m sensing range for opposed mode; 10m sensing range for retro-reflective mode, 2.5m sensing range for diffused mode; Wide voltage power supply, relay output. Suitable for garage, warehousing, logistics, crane anti-collision, etc.

Features:

- Multiple output modes
- Long sensing range
- Flexible mounting

Sensor function description:

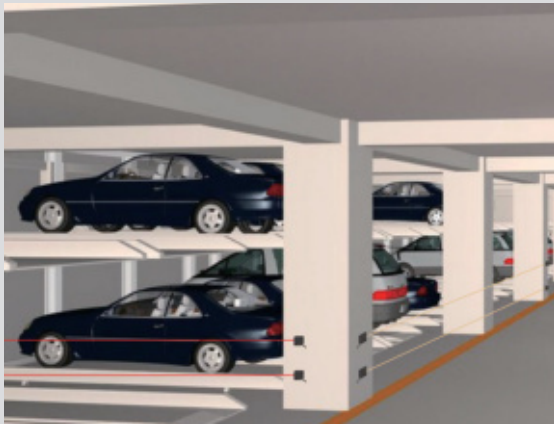

40m opposed for ultra-long distance detection, suitable for stereo garages, warehouses, 24-240V AC and DC power supply, relay output, no need for a separate 24V switching power supply.

Using a red LED light source that facilitates optical axis alignment, a 10m retro-reflective detection distance and a wide lateral width rolling shutter door can also be installed.



Type:

Detection mode	Type	Distance	Light source	Frequency	Output	Switching mode	Connection	Wiring
Opposed	OS50-S6 (emitter)	40m	Infrared	800Hz	---	---	2m cable	Fig.1
	OS50-EVP6 (receiver)		---		PNP	NO+NC		Fig.3
	OS50-EVN6 (receiver)		---		NPN			Fig.4
	OS50-S6Q (emitter)	40m	Infrared	800Hz	---	---	M12 connector	Fig.2
	OS50-EVP6Q (receiver)		---		PNP	NO+NC		Fig.5
	OS50-EVN6Q (receiver)		---		NPN			Fig.6
	OS50-S5 (emitter)	40m	Infrared	50Hz	---	---	2m cable	Fig.11
	OS50-EVR5 (receiver)		---		Relay	NO+NC		Fig.12
	OS50-S206 (emitter)	20m	Red	800Hz	---	---	2m cable	Fig.1
	OS50-E20VP6 (receiver)		---		PNP	NO+NC		Fig.3
	OS50-E20VN6 (receiver)		---		NPN			Fig.4
	OS50-S206Q (emitter)	20m	Red	800Hz	---	---	M12 connector	Fig.2
	OS50-E20VP6Q (receiver)		---		PNP	NO+NC		Fig.5
	OS50-E20VN6Q (receiver)		---		NPN			Fig.6
	OS50-S205 (emitter)	20m	Red	50Hz	---	---	2m cable	Fig.11
	OS50-E20VR5 (receiver)		---		Relay	NO+NC		Fig.12
	OS50-SL6(emitter)	60m	Laser	800Hz	---	---	2m cable	Fig.1
	OS50-ELVP6 (receiver)		---		PNP	NO+NC		Fig.3
	OS50-ELVN6 (receiver)		---		NPN			Fig.4
	OS50-SL6Q(emitter)	60m	Laser	800Hz	---	---	M12 connector	Fig.2
OS50-ELVP6Q (receiver)	---		PNP		NO+NC	Fig.5		
OS50-ELVN6Q (receiver)	---		NPN			Fig.6		
OS50-SL5(emitter)	60m	Laser	50Hz	---	---	2m cable	Fig.7	
OS50-ELVR5 (receiver)		---		Relay	NO+NC		Fig.8	

The detection distance corresponds to the reflector RB50*50-1

Retro-reflective	OS50-RVP6	10m	Red	800Hz	PNP	NO+NC	2m cable	Fig.3
	OS50-RVN6				NPN			Fig.4
	OS50-RVP6Q	10m	Red	800Hz	PNP	NO+NC	M12 connector	Fig.5
	OS50-RVN6Q				NPN			Fig.6
	OS50-RVR5	10m	Red	50Hz	Relay	NO+NC	2m cable	Fig.12
Polarized retro-reflective	OS50-RPVP6	6m	Red	800Hz	PNP	NO+NC	2m cable	Fig.3
	OS50-RPVN6				NPN			Fig.4
	OS50-RPVP6Q	6m	Red	800Hz	PNP	NO+NC	M12 connector	Fig.5
	OS50-RPVN6Q				NPN			Fig.6
	OS50-RPVR5	6m	Red	50Hz	Relay	NO+NC	2m cable	Fig.12

Type:

Detection mode	Type	Distance	Light source	Frequency	Output	Switching mode	Connection	Wiring
Diffused	OS50-K1000VP6	1000mm	Red	800Hz	PNP	NO+NC	2m cable	Fig.7
	NPN				Fig.8			
	OS50-K1000VP6Q	1000mm	Red	800Hz	PNP	NO+NC	M12 connector	Fig.9
	NPN				Fig.10			
	OS50-K1000VR5	1000mm	Red	50Hz	Relay	NO+NC	2m cable	Fig.12
	OS50-K2500VP6	2500mm	Infrared	800Hz	PNP	NO+NC	2m cable	Fig.7
	NPN				Fig.8			
	OS50-K2500VP6Q	2500mm	Infrared	800Hz	PNP	NO+NC	M12 connector	Fig.9
	NPN				Fig.10			
	OS50-K2500VR5	2500mm	Infrared	50Hz	Relay	NO+NC	2m cable	Fig.12
	OS50-K3500VP6	3500mm	Infrared laser	800Hz	PNP	NO+NC	2m cable	Fig.7
	NPN				Fig.8			
	OS50-K3500VP6Q	3500mm	Infrared laser	800Hz	PNP	NO+NC	M12 connector	Fig.9
	NPN				Fig.10			
	OS50-K3500VR5	3500mm	Infrared laser	50Hz	Relay	NO+NC	2m cable	Fig.12
	OS50-K7000VP6	7000mm	Infrared laser	800Hz	PNP	NO+NC	2m cable	Fig.7
	NPN				Fig.8			
	OS50-K7000VP6Q	7000mm	Infrared laser	800Hz	PNP	NO+NC	M12 connector	Fig.9
NPN	Fig.10							
OS50-K7000VR5	7000mm	Infrared laser	50Hz	Relay	NO+NC	2m cable	Fig.12	

Photoelectric Sensors—Rectangular-OS50

Technical Data:

Operating voltage	10...30VDC(NPN、PNP) 24...240VAC/DC(relay type)
Response time	Max,2ms(NPN、PNP) Max,30ms(relay type)
Repeatability	≤3%
Load current	≤200mA(NPN、PNP) ≤3A (relay type)
Protection circuit	Electrical surge, reverse polarity protection, short circuit protection Electrical surge protection (relay type)
Distance adjustment	Adjustable, with single-turn knob
Output type	NPN、PNP、Relay
Switch mode	NO+NC
Output indicator	Yellow LED
Steady state indicator	Green LED
Ambient temperature	-25...55°C
Spot size	4.5cm(1.2m)、7cm(2.4m)、9cm(3.5m)@OS50-K3500系列
Voltage resistance	1000V/AC 50/60Hz 60s
Insulation impedance	≥50MΩ(500VDC)
Shock resistance	Complex amplitude 1.5mm 10... 50Hz (2hr X, Y,Z respectively)
Impact resistance	500m/S ² (50G) 3 times X,Y,Z respectively
Protection class	IP67
Housing material	PBT+ABS
Accessories	Mounting bracket (all types) EOS50-1, reflector RB50*50-1 (only for retro-reflective and polarized retro-reflective)

Wiring:

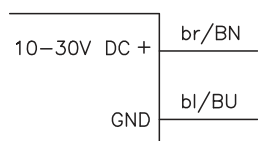

Fig.1

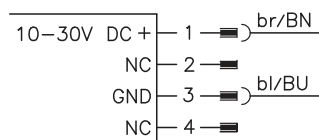

Fig.2

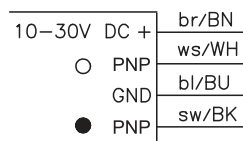

Fig.3

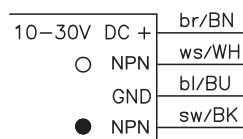

Fig.4

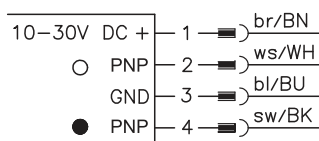

Fig.5

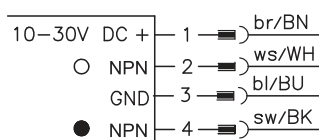

Fig.6

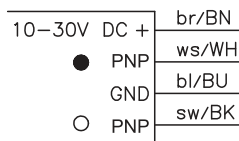

Fig.7

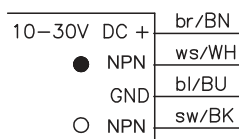

Fig.8

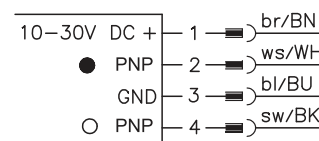

Fig.9

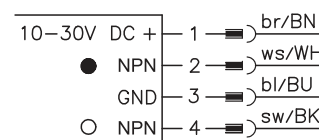

Fig.10

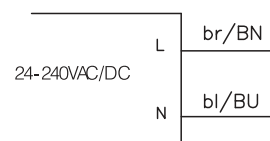

Fig.11

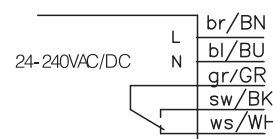
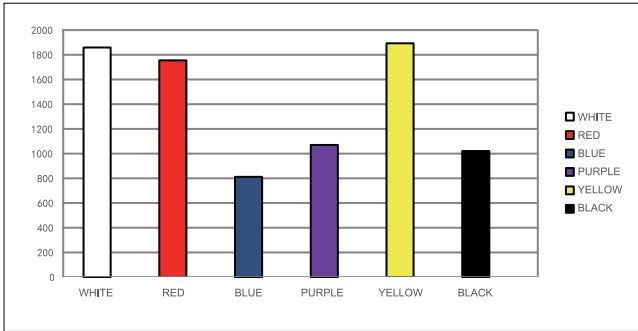

Fig.12

Photoelectric Sensors—Rectangular-OS50

Functional characteristics:

OS50-K1000VP6 diffused attenuation figure



OS50-K3500VP6 diffused attenuation figure

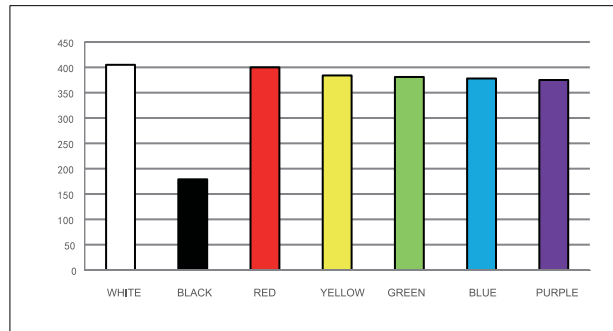

OS50-K1000VR5 diffused attenuation figure

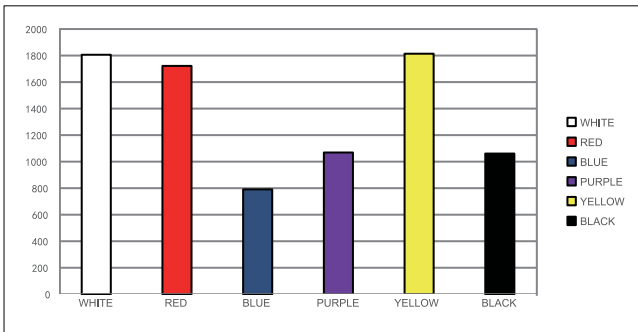

OS50-K7000VR5 diffused attenuation figure

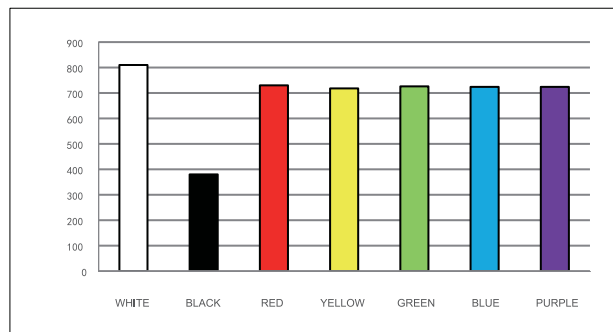

OS50 series translation characteristic curve

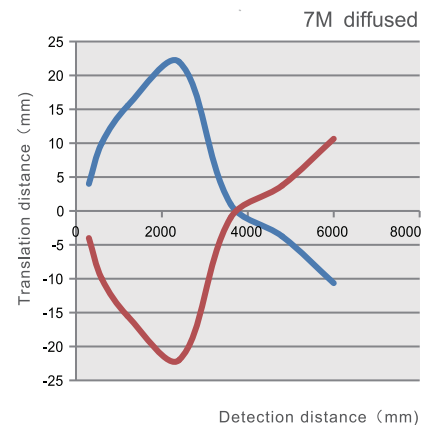
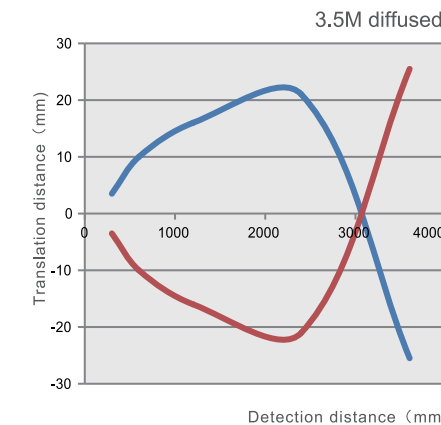
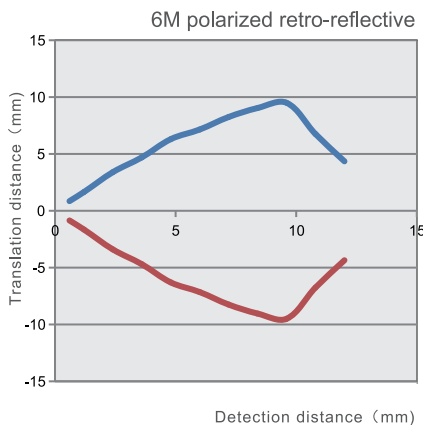
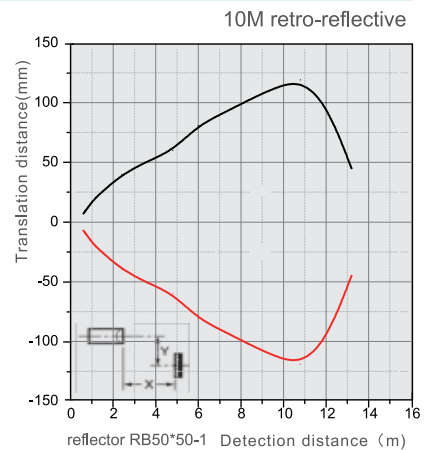
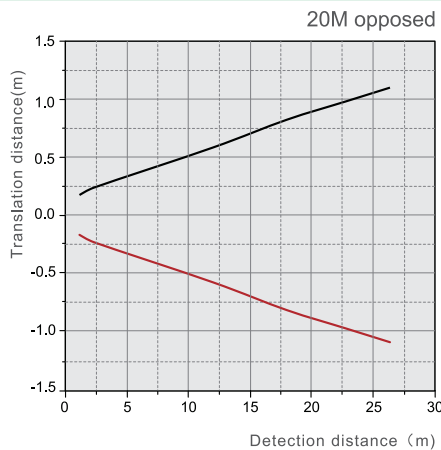
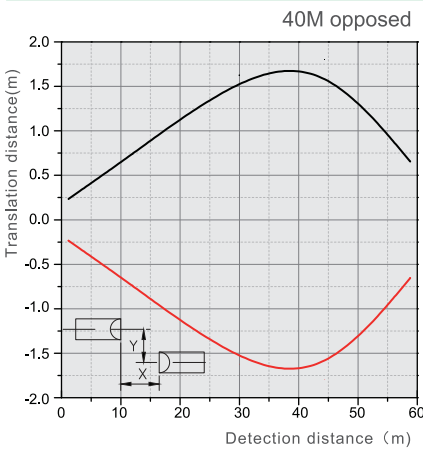

Dimensions:

M12 connector

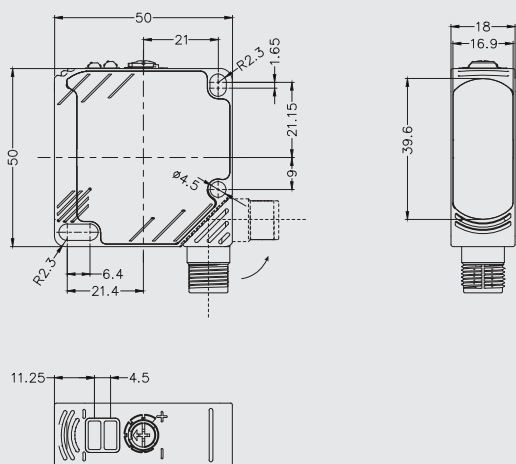

2m cable

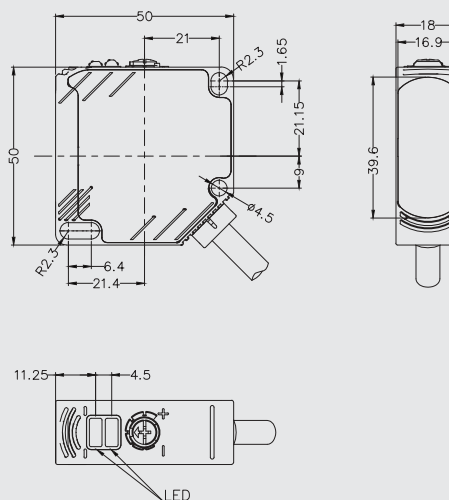

Mounting bracket (standard):

EOS50-1

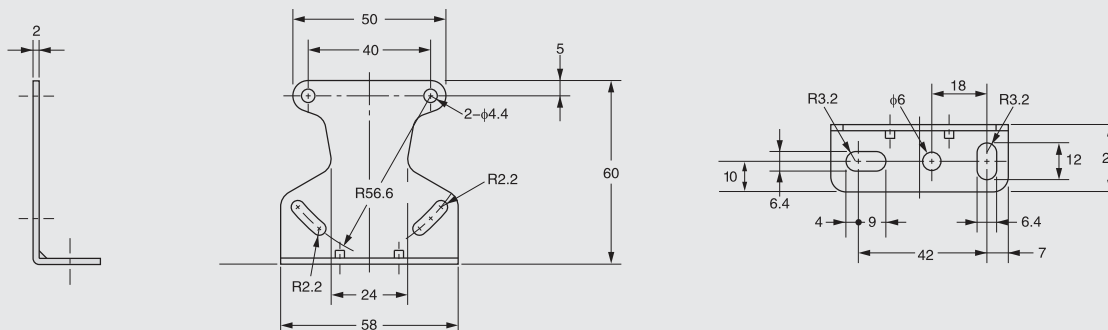

Reflector:

RB50x50-1 (standard)

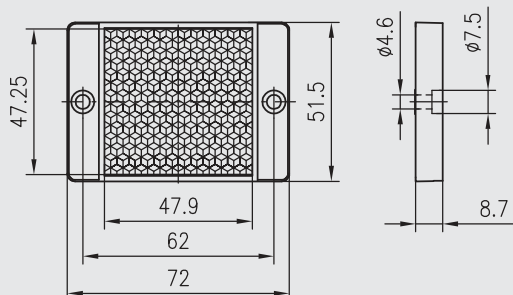

RB50x50 (optional)

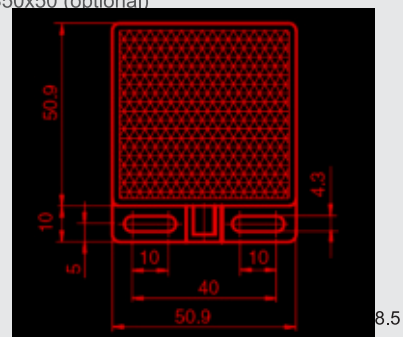

Photoelectric sensor - rectangular OSM70



Description:

Metal housing, 150m laser opposed, 30m laser retro-reflective, 25m laser polarized retro-reflective, 3m laser BGS diffuse, coaxial technology, no blind zone, precise positioning, wide voltage supply, relay output. Suitable for automotive manufacturing, metallurgical industry, non-standard equipment, textile machinery and others.

Features:

- BGS function greatly improves the detection effect
- Long detection distance
- Adjust the sensitivity by knob
- IP67 protection class
- Push-pull / relay output

Type: (light source-laser)

Detection mode	Type	Distance	Light source	Frequency	Output	Switching mode	Connection	Wiring
Opposed	OSM70-SL6	150m	Laser	---	---	---	2m cable	Fig.1
	OSM70-ELVB6		---	800Hz	Push-Pull	Light on / dark on	2m cable	Fig.4
	OSM70-SL6Q	150m	Laser	---	---	---	M12 4-pin connector	Fig.2
	OSM70-ELVB6Q		---	800Hz	Push-Pull	Light on / dark on	M12 4-pin connector	Fig.4
	OSM70-SL5	150m	Laser	---	---	---	2m cable	Fig.3
	OSM70-ELVR5		---	50Hz	Relay	Light on / dark on	2m cable	Fig.5
Retro-reflective	OSM70-RLVB6	30m	Laser	800Hz	Push-Pull	Light on / dark on	2m cable	Fig.6
	OSM70-RLVB6Q	30m	Laser	800Hz	Push-Pull	Light on / dark on	M12 4-pin connector	Fig.4
	OSM70-RLVR5	30m	Laser	50Hz	Relay	Light on / dark on	2m cable	Fig.5
Polarized retro-reflective	OSM70-RPLVB6	25m	Laser	800Hz	Push-Pull	Light on / dark on	2m cable	Fig.6
	OSM70-RPLVB6Q	25m	Laser	800Hz	Push-Pull	Light on / dark on	M12 4-pin connector	Fig.4
	OSM70-RPLVR5	25m	Laser	50Hz	Relay	Light on / dark on	2m cable	Fig.5
BGS	OSM70-AKL3000VB6	3m	Laser	10Hz	Push-Pull	Light on / dark on	2m cable	Fig.6
	OSM70-AKL3000VB6Q	3m	Laser	10Hz	Push-Pull	Light on / dark on	M12 4-pin connector	Fig.4
	OSM70-AKL3000VR5	3m	Laser	10Hz	Relay	Light on / dark on	2m cable	Fig.5

Technical Data:

Operating voltage	10...30VDC (push-pull), 24...240VAC/DC (relay)
Ripple voltage	≤10%
Switch output	Push-Pull, Relay
Output characteristics	Light on + dark on
Repeatability	≤3%
light source	650nm laser
Spot diameter	5mm (at 7m), 15mm (at 20m)
No-load current	≤30mA
Load current	≤450mA (push-pull), ≤3A (relay)
Protection circuit	Reverse polarity protection (push-pull), short circuit protection, surge protection (relay), overload protection
Output indicator	Red LED
Steady state indicator	Green LED
Housing material	Die-cast aluminum
Connection	M12 connector / 2 meter cable
Operating temperature	-25°C...55°C
Storage temperature	-40°C...70°C
Detection mode	BGS、 Window mode、 FGS (OSM70-AKL3000)
Voltage resistance	1000V/AC 50/60Hz 60s
Insulation impedance	≥50MΩ (500VDC)
Shock resistance	Complex amplitude 1.5mm 10... 50Hz (2hr X, Y,Z respectively)
Impact resistance	500m/S ² (50G) 3 times X,Y,Z respectively
Protection class	IP67
Dimensions	27×54×84mm

Wiring:

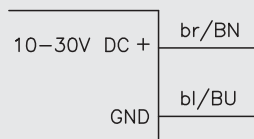

Fig.1

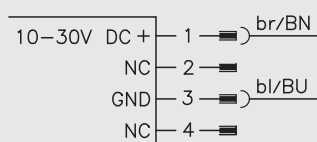

Fig.2

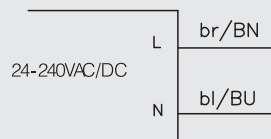
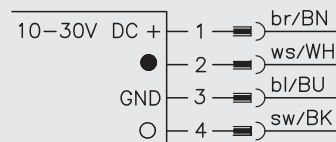

Fig.3



○ = Light on
● = Dark on

Fig.4

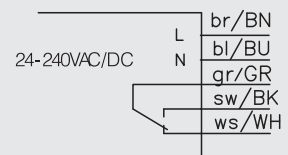
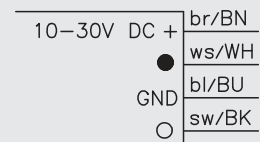

Fig.5



○ = Light on
● = Dark on

Fig.6

Dimensions:

M12 connector

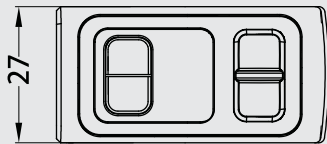
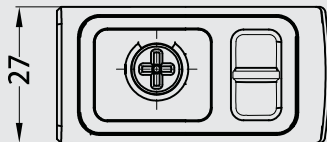
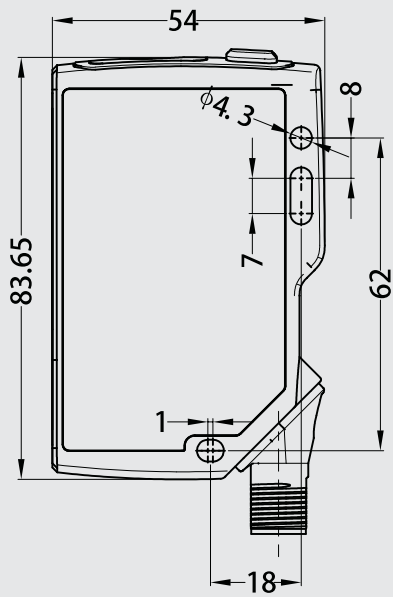

2 meter cable

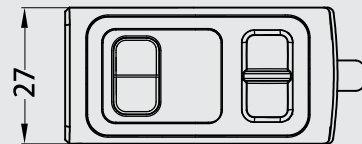
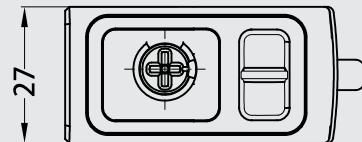
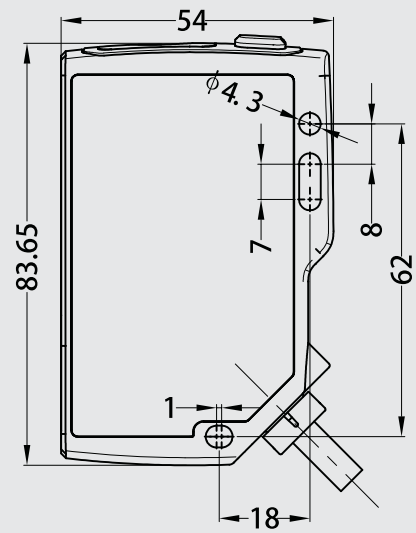

Photoelectric sensor - OSM40



Description:

Laser displacement sensor, 655nm laser source, metal housing, LED display and button settings, rich interface. Suitable for pharmaceutical, packaging, automotive, non-standard equipment and others.

Features:

- LED digital display + teaching function
- Strong resistance to ambient light, compact size
- Analog/switch dual output

Type:

Type	Distance	Beam	Output	Resolution	Connection	Wiring
OSM40-KL70CBLI6	35...70mm	Red laser	NPN/PNP+analog mA	0.01mm	2m cable	Fig.1
OSM40-KL70CBLU6	35...70mm	Red laser	NPN/PNP+analog V	0.01mm	2m cable	Fig.1
OSM40-KL70CBLI6Q12.1	35...70mm	Red laser	NPN/PNP+analog mA	0.01mm	M12 connector	Fig.1
OSM40-KL70CBLU6Q12.1	35...70mm	Red laser	NPN/PNP+analog V	0.01mm	M12 connector	Fig.1
OSM40-KL800CBLI6	150...800mm	Red laser	NPN/PNP+analog mA	0.1mm	2m cable	Fig.1
OSM40-KL800CBLU6	150...800mm	Red laser	NPN/PNP+analog V	0.1mm	2m cable	Fig.1
OSM40-KL800CBLI6Q12.1	150...800mm	Red laser	NPN/PNP+analog mA	0.1mm	M12 connector	Fig.1
OSM40-KL800CBLU6Q12.1	150...800mm	Red laser	NPN/PNP+analog V	0.1mm	M12 connector	Fig.1

Technical Data:

Supply voltage	10-30VDC
Ripple voltage	≤10%
No-load current	≤150mA
Power	1.5W
Analog output	4...20mA, 0...5V or 0...10V
Switch output	NPN/PNP
Light source	655nm laser source
Protection circuit	Reverse polarity protection, short circuit protection, Overload protection
Response time	1.5ms / 5ms / 10ms switchable
Repeatability	0.05mm(at 35...70mm); 0.5mm(at 150...400mm); 1mm(at 400...600mm); 3mm(at 600...800mm)
Spot diameter	1mm@150mm; 2mm@600mm
Housing material	Stainless steel
Ambient temperature	-10 C-45 C
Voltage resistance	1000V/AC 50/60Hz 60s
Insulation impedance	≥50MΩ (500VDC)
Shock resistance	Complex amplitude 1.5mm 10... 50Hz (2hr X, Y,Z respectively)
Impact resistance	500m/S ² (50G) 3 times X,Y,Z respectively
Connection	M12 5-pin connector
Protection class	IP67
Dimensions	60.4*20*35.5mm

Interface output:

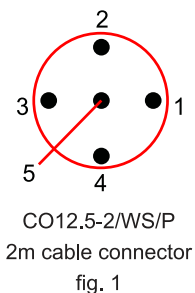

Serial number	Wire color	Function
1	brown	10...30VDC
2	white	Q _A ANALOG OUTPUT(I/U)
3	blue	0V
4	black	PNP/NPN
5	grey	N/A

Dimensions:

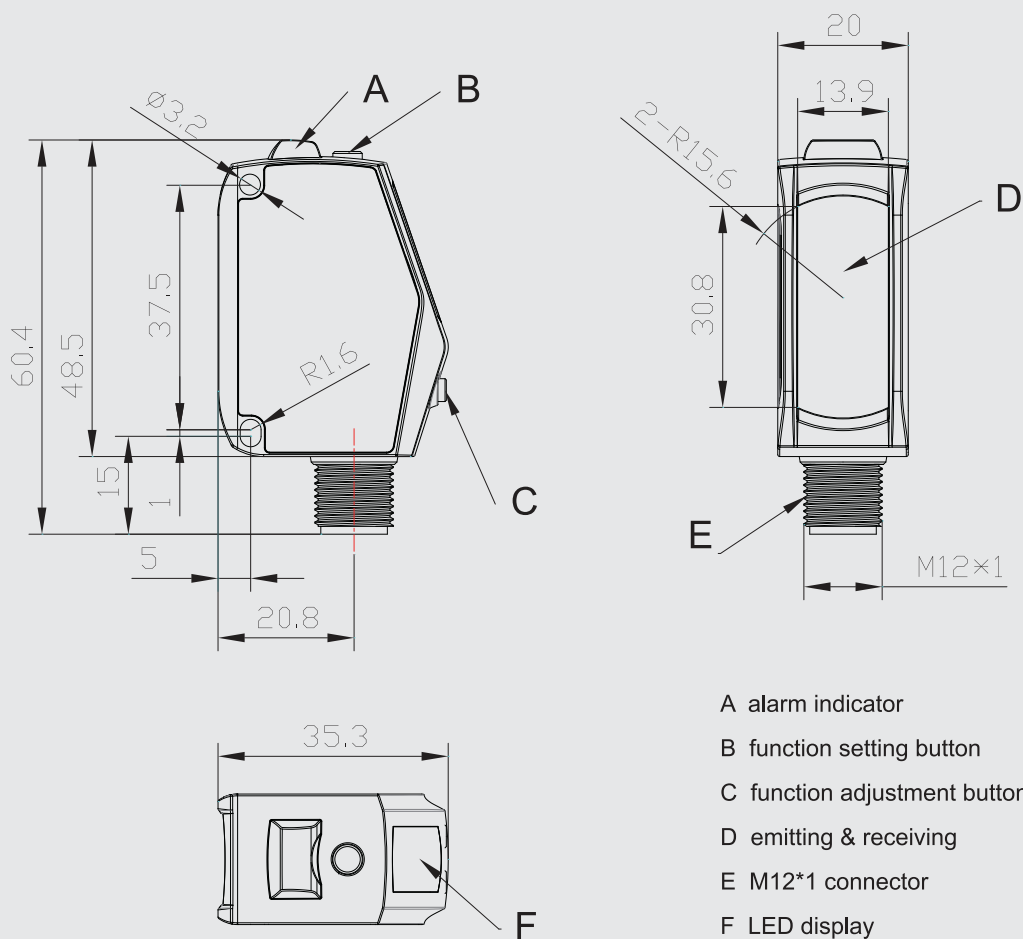



Coming 2021

Description:

Laser ranging sensor, Laser source, metal housing. Can be displayed by LED and set by button, Multiple interfaces. Suitable for automobile manufacturing, equipment manufacturing, crane anti-collision, AGV and others.

Features:

- LED display + LED indicator
- Teach button setting
- Strong resistance to extreme light interference
- Compact size
- Analog, switch dual output

Type:

Type	Distance	Light source	Frequency	Output	Resolution	Connection	Wiring
OSM60-KL10V2BLIU6Q12.8/R	0.2-10m	Red laser	— —	2×Push-Pull Analog mA/V	5mm	M12 connector	Fig.1

Technical Data:

Operating voltage	10-30VDC
Power	< 1W
Analog output	Voltage 0-10V, current 4-20mA
Switch output	2×Push-pull
Resolution(mm)	5mm
Preheat time	30min
Measurement accuracy	±5cm
Response time	20ms
Repeatability	1cm
Green LED is bright	Ready
Yellow LED flashes	Object detection, teaching
Housing material	Stainless steel
Spot size/distance	About φ2cm/10m
Ambient temperature	-20°C...+50°C
Connection	M12 connector
Protection class	IP67
Dimensions	68.5x69.7x37mm

Interface output:

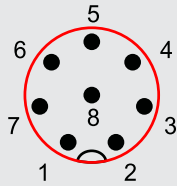

CO12.8-2/WS/P
2m connector
Fig. 1

Serial number	Wire color	Function
1	white	N/A
2	brown	10...30VDC
3	green	Q _x ANALOG OUTPUT(I)
4	yellow	Q1
5	grey	Q2
6	pink	Q _v ANALOG OUTPUT(V)
7	blue	0V
8	red	TRIGGER





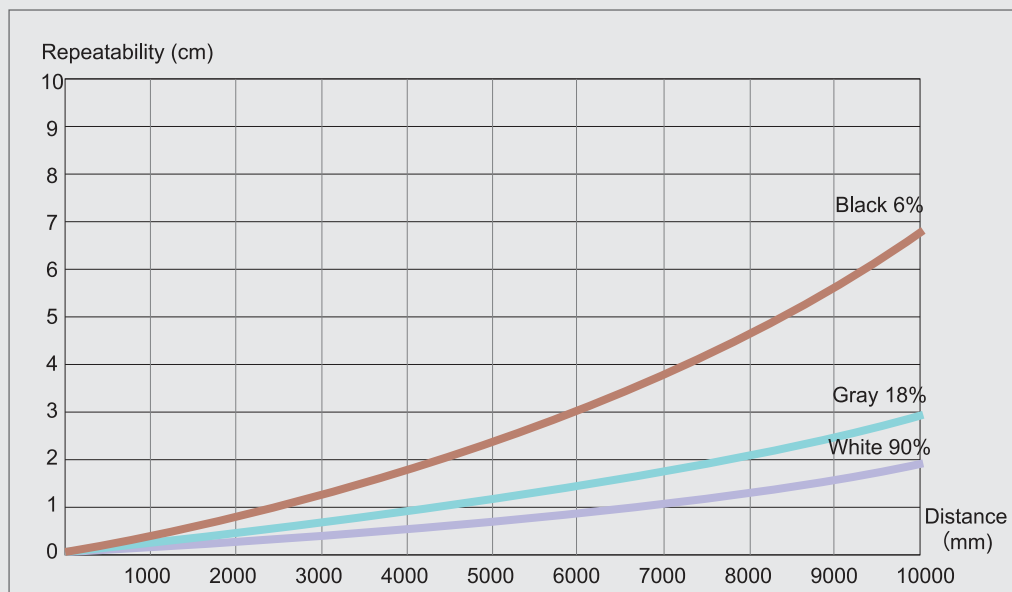

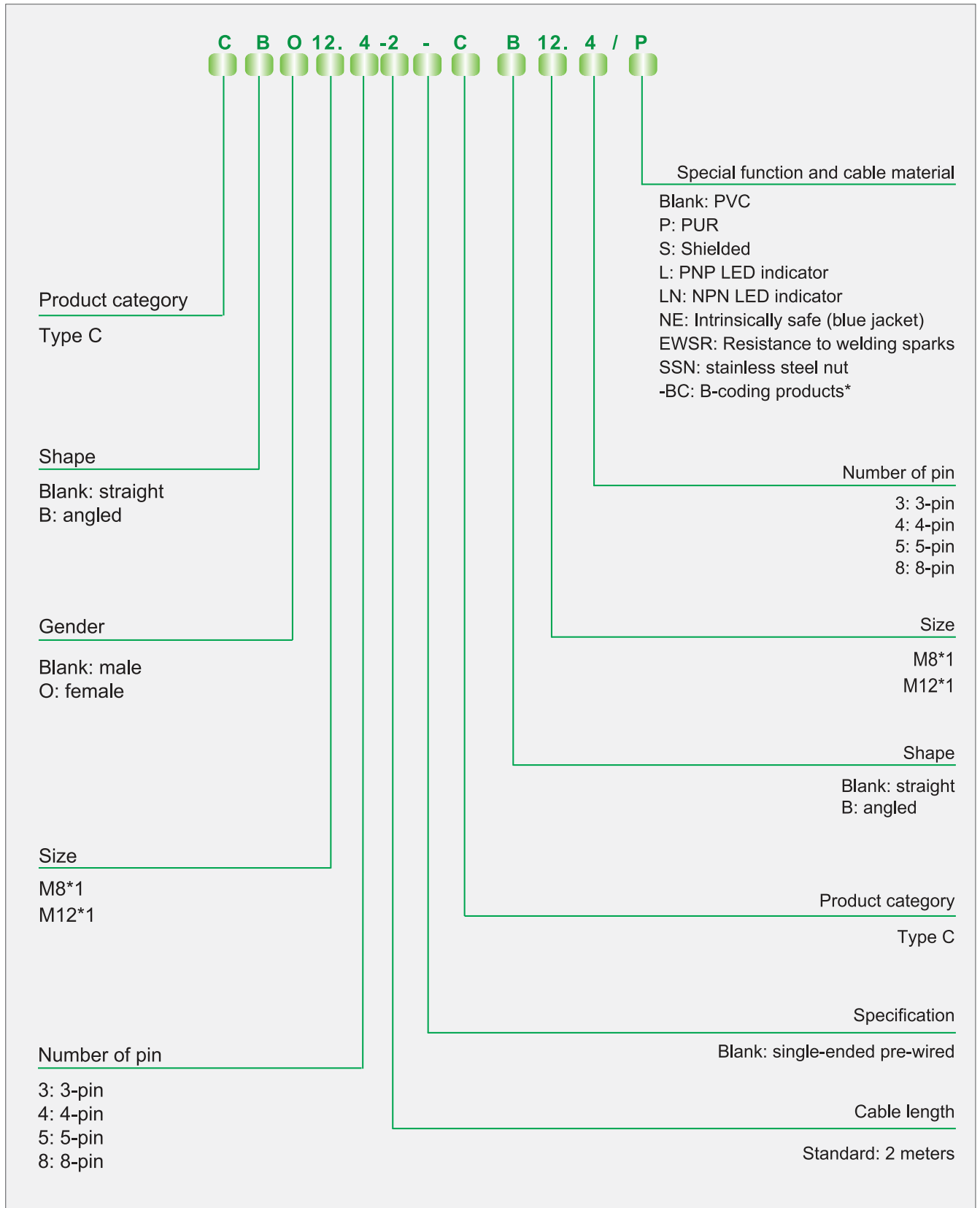

Repeatability:

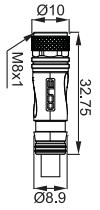
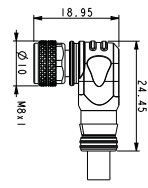
Repeatability (cm)
[white 90%, gray 18%, black 6%]

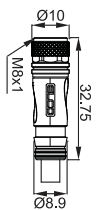
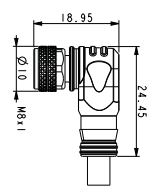

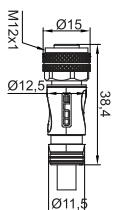
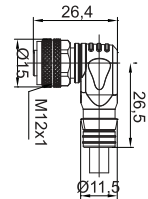
Accessories - connector

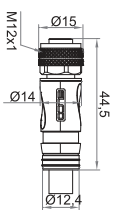
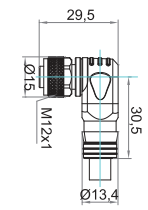

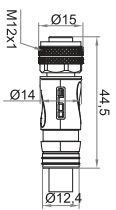
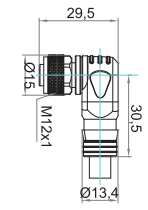
Size and pin assignment	Adapter connector																	
	Straight	Angled																
M8  <table border="1" data-bbox="365 541 462 619"> <tr><td>1</td><td>br/BN</td></tr> <tr><td>2</td><td>bl/BU</td></tr> <tr><td>3</td><td>sw/BK</td></tr> <tr><td>4</td><td></td></tr> </table>	1	br/BN	2	bl/BU	3	sw/BK	4											
1	br/BN																	
2	bl/BU																	
3	sw/BK																	
4																		
M8  <table border="1" data-bbox="365 829 462 940"> <tr><td>1</td><td>br/BN</td></tr> <tr><td>2</td><td>ws/WH</td></tr> <tr><td>3</td><td>bl/BU</td></tr> <tr><td>4</td><td>sw/BK</td></tr> </table>	1	br/BN	2	ws/WH	3	bl/BU	4	sw/BK										
1	br/BN																	
2	ws/WH																	
3	bl/BU																	
4	sw/BK																	
M12  <table border="1" data-bbox="365 1128 462 1238"> <tr><td>1</td><td>br/BN</td></tr> <tr><td>2</td><td>ws/WH</td></tr> <tr><td>3</td><td>bl/BU</td></tr> <tr><td>4</td><td>sw/BK</td></tr> </table>	1	br/BN	2	ws/WH	3	bl/BU	4	sw/BK										
1	br/BN																	
2	ws/WH																	
3	bl/BU																	
4	sw/BK																	
M12  <table border="1" data-bbox="365 1437 527 1570"> <tr><td>1</td><td>br/BN</td></tr> <tr><td>2</td><td>ws/WH</td></tr> <tr><td>3</td><td>bl/BU</td></tr> <tr><td>4</td><td>sw/BK</td></tr> <tr><td>5</td><td>Blindloch/ dummy hole</td></tr> </table>	1	br/BN	2	ws/WH	3	bl/BU	4	sw/BK	5	Blindloch/ dummy hole								
1	br/BN																	
2	ws/WH																	
3	bl/BU																	
4	sw/BK																	
5	Blindloch/ dummy hole																	
M12  <table border="1" data-bbox="365 1714 462 1891"> <tr><td>1</td><td>ws/WH</td></tr> <tr><td>2</td><td>br/BN</td></tr> <tr><td>3</td><td>gn/GN</td></tr> <tr><td>4</td><td>ge/YE</td></tr> <tr><td>5</td><td>gr/GY</td></tr> <tr><td>6</td><td>rs/PK</td></tr> <tr><td>7</td><td>bl/BU</td></tr> <tr><td>8</td><td>rt/RD</td></tr> </table>	1	ws/WH	2	br/BN	3	gn/GN	4	ge/YE	5	gr/GY	6	rs/PK	7	bl/BU	8	rt/RD		
1	ws/WH																	
2	br/BN																	
3	gn/GN																	
4	ge/YE																	
5	gr/GY																	
6	rs/PK																	
7	bl/BU																	
8	rt/RD																	

Reflector:

RB50x50

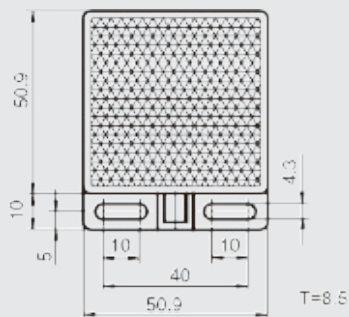

RB40x60

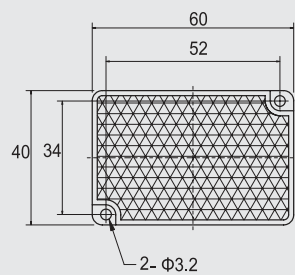

RB40x60-1

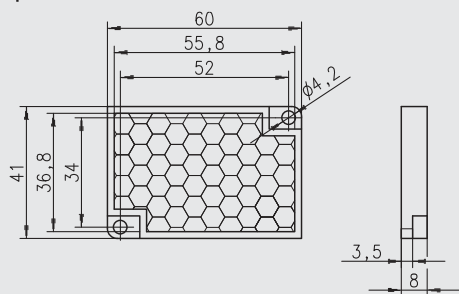

RB50x50-1

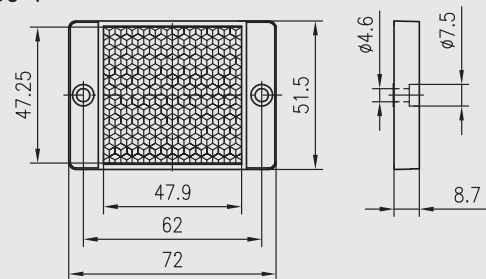

RB80

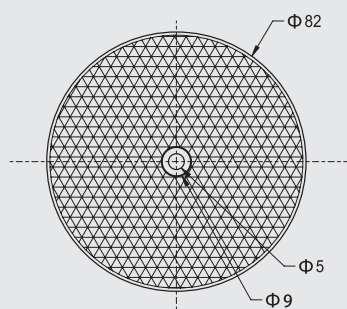

RB100x100

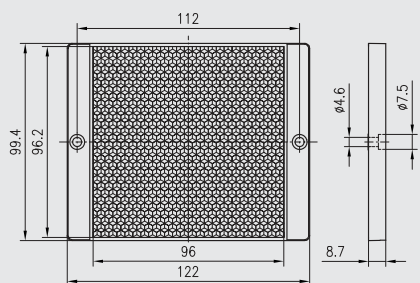

Reflective tape
RT50-1

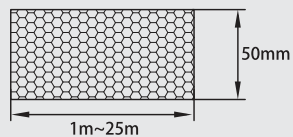

Slit:

OS12 series slit
SOS12-1

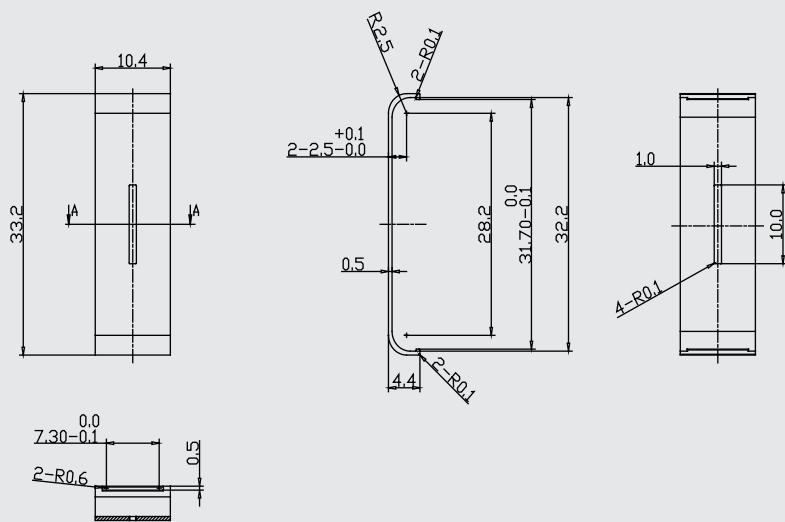

OM18\OP18\OG18 slit
SOM18-1

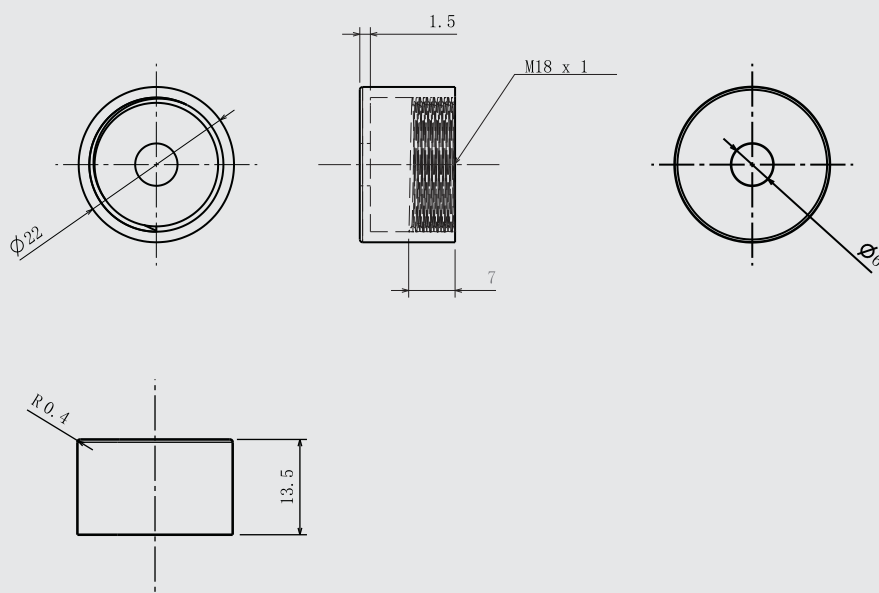

ELCO Industrie Automation GmbH
Benzstrasse 7
71720 Oberstenfeld
Deutschland
E-Mail: info@elco-automation.de



www.elco-automation.de

ELCO (TIANJIN) ELECTRONICS CO., LTD.
No. 12, 4th XEDA Branch Road
Xiqing Economic Development Area
Tianjin 300385, P. R. China
E-Mail: info@elco.cn



www.elco-holding.com.cn